



2026 CATALOG



THE LEADING WHOLESALE DISTRIBUTOR OF BUILDING MATERIALS IN THE MIDWEST





2026 PRODUCT CATALOG

Welcome to our Product Catalog. We have compiled a comprehensive list of everything we stock and sell. It encompasses over 2,000 different products that are available every single day. Of course, we also have the ability to special order just about anything; if it's wood, we can source it.

We're a family-run company that's been in the wood products industry for over a hundred years, and we're currently on our third generation of family ownership and management.

Our whole philosophy is to source the best building materials in the world and provide quick and reliable access to them for any sized job, big or small.

Thank you for your support!



PAGE GUIDE

1.....8: *Introduction*

9.....20: *Engineered Wood*

21.....31: *Lumber*

32.....50: *Panels*

51.....62: *Boards*

63.....81: *Cedar*

82.....90: *Fir*

91...109: *Decking*

110..132: *Siding & Trim*

133..135: *Concrete Forming Products*





PRODUCT BROCHURE

St. Louis Fast Facts:

- 30 Acres and 250,000 Sq Ft of Enclosed Warehouse Space
- 16 Sales Reps, 16 Drivers, 28 Yardmen, 3 Office Admins
- 23 Flatbeds, 3 Hotshot Trailers, 2 Roll-off Trailers
- Over 2,000 SKU's in Inventory and On Ground
- Family Owned and Operated



REMANUFACTURING FACILITY

P.E.T. SAW:

Capable of Precision End Trimming units of lumber to exact lengths.



RESAW AND PLANER:

Resize and Surface (S4S) Douglas Fir, Western Red Cedar timbers and more.

Resaw Max Size 12" x 16"

Planer Max Size 16" x 24"



GANG RIP SAW:

Cut boards into desired specified widths. *Max Size 4" x 12"*



Contact Your Forest Products Rep

To Get a Quote and Lead Time

OUR WEBSITE

www.fp-supply.com/st-louis-resources.html



VISIT OUR WEBSITE FOR MORE INFORMATION ON ALL OF OUR PRODUCTS.

Go to www.fp-supply.com, and then go to resources and select St. Louis.

Here you'll have detailed access to all of our products. Every product page includes relevant information you're looking for, including available sizes, photos, videos, PDF's of installation guides, product brochures, MSDS sheets, specifier's guides, and more.

The best part is that everything is designed for the dealer to be able to share with their customers, so we don't include any pricing on these pages. Use this as a selling tool and share these product pages and links with your customers to help close sales. It's also a mobile friendly site, so you can access this on a jobsite with a smartphone or tablet. We also have access to our price pages online via a user login page. With this, you can quote jobs at all hours of the day and have quick and easy access to all of our pricing.

OUR POSTERS



We have created New Posters intended for product store signage. Our new posters are designed to be both informative and eye-catching to help educate your customers and drive sales. They are available free of charge and are easy to put on a wall, corkboard, countertop, etc.

If you would like to request some posters for your store, go to www.fp-supply.com/fp-posters.html and fill out our online form or call us at (314) 961-6195. The posters measure 20" x 30" and feature a QR code that can be scanned that takes the customer to our website for more comprehensive information.

Available Posters:

- *Pattern Stock*
- *PVC Moulding*
- *EasyTrim*
- *Doug Fir Timbers*
- *Cedar Timbers*
- *Cedar Shakes & Shingles*
- *Trus Joist TJI*
- *TimberStrand LSL Framing*
- *Affinity Stone Siding*
- *James Hardie Siding*
- *James Hardie Artisan Siding*
- *Plywood Siding*
- *Premium Boards*
- *WynnWood Boards*
- *Trus Joist LVL Microllams*
- *WoodTone Cedar Post*
- *Deckorators Venture Decking*
- *Deckorators Vista Decking*
- *Deckorators Voyage Decking*
- *TigerDeck Decking*
- *GatorBar*
- *Treated Glulam Beams*
- *Trus Joist Parallam PSL Beams*
- *WoodTone T&G Paneling*

STAY CONNECTED AND LEARN



www.youtube.com/@forestproductssupply

We post product videos, installation instructions, featured projects, and more on our YouTube channel. We plan to post regular Product Knowledge videos.



www.instagram.com/forest_products_supply/

We post content of our products being used in the field. This is a simple and easy way to see how material is used, learn about products, and see good work. We like to engage the whole supply chain and often repost content from suppliers, contractors, and builders. Sometimes, a picture is worth a thousand words.



<http://eepurl.com/dvF2d5>

We send out weekly marketing emails that highlight specific products. We tend to focus on the peripheral items and these emails are a quick and easy way to learn about what we stock, the features and benefits, general installation guidelines, and FAQ's. We also include a fun trivia question in every email.

ENGINEERED WOOD PRODUCTS



Trus Joist Engineered Wood Products are the #1 rated I-Joist by Builder Magazine, and have been for 15 years running. They are the only brand with a full suite of engineered wood products including I-Joists, LVL Microllam, PSL Parallam, and LSL Timberstrand.

From performance, to assortment, to quality, Trus Joist is the clear market leader and has the proven performance that builders trust nationwide. Additionally, we have a team of five engineers that can help with questions, design, and trouble-shooting from start to finish.

OUR SERVICES

CONSULTING



DESIGN



JOBSITE DELIVERY



TJI I-JOISTS



Available Sizes:

Model	Flange	Lengths	Hangers		L/480* Span @ 16" O.C.
			Top Mount	Face Mount	
9-1/2" TJI 110	1-3/4"	12' - 48'	ITS1.81/9.5	IUS1.81/9	15'-6"
11-7/8" TJI 210	2-1/16"	12' - 48'	ITS2.06/11.88	IUS2.06	19'-3"
11-7/8" TJI 360	2-5/16"	12' - 48'	ITS2.37/11.88	IUS2.37	20'-11"
11-7/8" TJI 560	3-1/2"	12' - 48'	ITS3.56/11.88	HHUS410	23'-8"
14" TJI 360	2-5/16"	12' - 48'	ITS2.37/14	IUS2.37/14	23'-8"
14" TJI 560	3-1/2"	12' - 48'	MIT414	-	26'-10"
16" TJI 360	2-5/16"	12' - 48'	MIT3516	IUS2.37/14	26'-3"
16" TJI 560	3-1/2"	12' - 48'	MIT416	-	29'-3"

*40 PSF Live Load / 10 PSF Dead Load

Features & Benefits:

- The #1 rated I-Joist by Builder Magazine for 15 years running
- LVL flange for superior fastening power and squeak-free floor
- Pre-notched holes for easy to run mechanicals
- Multiple depths and flange widths for any conceivable design
- 18" and 20" TJI's are available on a special-order basis

TIMBERSTRAND FIRE CODE APPROVED FLOOR JOISTS



Available Sizes:

Item	Available Lengths	E-Value	Span @ 16" O.C.		Hangers	
			L/360 Span	L/480 Span	Face Mount	Top Mount
1-1/2" x 11-7/8" LSL	12' - 48'	1.5 E	21'-11"	19'-10"	HUS212	ITS1.56/11.88

Features & Benefits:

- Meets newest IRC and ICC code for foundation level fire code approval
- Superior strength and span rating to 2x10 or 2x12 Yellow Pine
- Perfectly straight and consistent, and will prevent floor squeaks
- Compatible with the entire Trus Joist system
- Cost-effective solution – no need for sheetrock or additional labor to meet code

LVL MICROLLAM



Available Sizes:

Depth	Thickness	Lengths	E-Value	Overlay	Unit Size
5-1/2"	1-3/4"	12' - 48'	2.0 E	Watershed	48
7-1/4"	1-3/4"	12' - 48'	2.0 E	Watershed	36
9-1/4"	1-3/4"	12' - 48'	2.0 E	Watershed	30
9-1/2"	1-3/4"	12' - 48'	2.0 E	Watershed	30
11-1/4"	1-3/4"	12' - 48'	2.0 E	Watershed	24
11-7/8"	1-3/4"	12' - 48'	2.0 E	Watershed	24
14"	1-3/4"	12' - 48'	2.0 E	Watershed	18
16"	1-3/4"	12' - 48'	2.0 E	Watershed	18
18"	1-3/4"	12' - 48'	2.0 E	Watershed	12
20"	1-3/4"	12' - 48'	2.0 E	Watershed	12
24"	1-3/4"	12' - 48'	2.0 E	Watershed	12

Features & Benefits:

- Waxy watershed overlay finish that beads water and improves long-term storage
- A large mix of depths and lengths for any conceivable application
- Available beam sizing and design by our engineers

TIMBERSTRAND HEADERS & BEAMS



Available Sizes:

Item	SKU	Lengths	E-Value	Unit Size
1-3/4" x 9-1/2"	19_TS	12' - 48'	1.55 E	30
1-3/4" x 11-7/8"	111_TS	12' - 48'	1.55 E	24
1-3/4" x 14"	114_TS	12' - 48'	1.55 E	18
3-1/2" x 9-1/2"	39_TS	12' - 48'	1.55 E	15
3-1/2" x 11-7/8"	311_TS	12' - 48'	1.55 E	12
3-1/2" x 14"	314_TS	12' - 48'	1.55 E	9

Features & Benefits:

- Perfectly straight – no bowing, twisting, or warping
- A less expensive alternative to LVL beams and headers
- A larger allowable hole zone for mechanicals like plumbing and electrical
- Available beam sizing and design by our engineers

TIMBERSTRAND FRAMING



Available Sizes:

Item	SKU	Actual Size	Lengths	E-Value
<i>2 x 4 Stud</i>	<i>2410458TS</i>	<i>1-1/2" x 3-1/2"</i>	<i>104-5/8"</i>	<i>1.30 E</i>
<i>2 x 6 Stud</i>	<i>2610458TS</i>	<i>1-1/2" x 5-1/2"</i>	<i>104-5/8"</i>	<i>1.30 E</i>
<i>2 x 4 Framing</i>	<i>24_TS</i>	<i>1-1/2" x 3-1/2"</i>	<i>12' - 48'</i>	<i>1.30 E</i>
<i>2 x 6 Framing</i>	<i>26_TS</i>	<i>1-1/2" x 5-1/2"</i>	<i>12' - 48'</i>	<i>1.30 E</i>
<i>2 x 8 Framing</i>	<i>28_TS</i>	<i>1-1/2" x 7-1/4"</i>	<i>12' - 48'</i>	<i>1.30 E</i>
<i>2 x 4 Treated Plate</i>	<i>2416TSP</i>	<i>1-1/2" x 3-1/2"</i>	<i>16'</i>	<i>1.30 E</i>
<i>2 x 6 Treated Plate</i>	<i>2616TSP</i>	<i>1-1/2" x 5-1/2"</i>	<i>16'</i>	<i>1.30 E</i>

Features & Benefits:

- Perfectly straight – no bowing, twisting, or warping
- A major component in tall walls and two story rooms
- Excellent for kitchens and bathrooms where you need perfectly straight walls
- Helps resist tile, grout, and sheetrock cracks and ensures that cabinets, doors and windows work smoothly and hang straight

PSL PARALLAMS



Available Sizes:

Item	Lengths	Brand	E-Value	Application
3-1/2" x 9-1/4"	8' - 48'	Trus Joist Parallam	2.0 E	Beams
3-1/2" x 11-1/4"	8' - 48'	Trus Joist Parallam	2.0 E	Beams
3-1/2" x 11-7/8"	8' - 48'	Trus Joist Parallam	2.0 E	Beams
3-1/2" x 14"	8' - 48'	Trus Joist Parallam	2.0 E	Beams
3-1/2" x 16"	8' - 48'	Trus Joist Parallam	2.0 E	Beams
3-1/2" x 18"	8' - 48'	Trus Joist Parallam	2.0 E	Beams
5-1/4" x 9-1/4"	8' - 48'	Trus Joist Parallam	2.0 E	Beams
5-1/4" x 11-1/4"	8' - 48'	Trus Joist Parallam	2.0 E	Beams
5-1/4" x 11-7/8"	8' - 48'	Trus Joist Parallam	2.0 E	Beams
5-1/4" x 14"	8' - 48'	Trus Joist Parallam	2.0 E	Beams
5-1/4" x 16"	8' - 48'	Trus Joist Parallam	2.0 E	Beams
5-1/4" x 18"	8' - 48'	Trus Joist Parallam	2.0 E	Beams
3-1/2" x 3-1/2"	8' - 48'	Trus Joist Parallam	1.8 E	Columns & Posts
3-1/2" x 5-1/4"	8' - 48'	Trus Joist Parallam	1.8 E	Columns & Posts
3-1/2" x 7"	8' - 48'	Trus Joist Parallam	1.8 E	Columns & Posts
5-1/4" x 5-1/4"	8' - 48'	Trus Joist Parallam	1.8 E	Columns & Posts
5-1/4" x 7"	8' - 48'	Trus Joist Parallam	1.8 E	Columns & Posts
7" x 7"	8' - 48'	Trus Joist Parallam	1.8 E	Columns & Posts

- Parallams are the biggest and strongest beams in the EWP family, and are made using parallel strands of lumber that are pressed and glued to form one solid beam
- One piece install, no need for multiple plies and fastening

DOUGLAS FIR GLULAM BEAMS



Available Sizes:

Item	Available Length	Hangers	Design Value	Grade
3-1/2" x 9-1/2"	12' - 60'	HU410 / HUC410	24F-V4 1.8E	Architectural
3-1/2" x 11-7/8"	12' - 60'	HU410 / HUC410	24F-V4 1.8E	Architectural
3-1/2" x 14"	12' - 60'	HU410 / HUC410	24F-V4 1.8E	Architectural
3-1/2" x 16"	12' - 60'	HU410 / HUC410	24F-V4 1.8E	Architectural
5-1/2 x 9-1/2	12' - 60'	HU610 / HUC610	24F-V4 1.8E	Architectural
5-1/2" x 11-7/8"	12' - 60'	HU610 / HUC610	24F-V4 1.8E	Architectural
5-1/2" x 14"	12' - 60'	HU610 / HUC610	24F-V4 1.8E	Architectural
5-1/2" x 16"	12' - 60'	HU610 / HUC610	24F-V4 1.8E	Architectural

Features & Benefits:

- Architectural appearance that takes stains exceptionally well.
- Sanded Face and micro-eased edges.
- Knots and voids are Filled
- Full 3.5" and 5.5" widths for perfect framing fit.
- Compatible with Common I joist depths.
- 1.9E true stress rating.
- Custom sizes, species and curves accessible.

DOUGLAS FIR TREATED GLULAM BEAMS



Available Sizes:

Size	Available Lengths	Hangers	Design Value	Treatment
3-1/2" x 9-1/2"	12' - 48' *	HU410 / HUC410	24F-V4 1.8E	HI-CLEAR II Treated
3-1/2" x 11-7/8"	12' - 48' *	HU410 / HUC410	24F-V4 1.8E	HI-CLEAR II Treated
3-1/2" x 14"	12' - 48' *	HU410 / HUC410	24F-V4 1.8E	HI-CLEAR II Treated
3-1/2" x 16"	12' - 48' *	HU410 / HUC410	24F-V4 1.8E	HI-CLEAR II Treated
5-1/2" x 9-1/2"	12' - 48' *	HU610 / HUC610	24F-V4 1.8E	HI-CLEAR II Treated
5-1/2" x 11-7/8"	12' - 48' *	HU610 / HUC610	24F-V4 1.8E	HI-CLEAR II Treated
5-1/2" x 14"	12' - 48' *	HU610 / HUC610	24F-V4 1.8E	HI-CLEAR II Treated
5-1/2" x 16"	12' - 48' *	HU610 / HUC610	24F-V4 1.8E	HI-CLEAR II Treated
5-1/2" x 5-1/2"	12' - 48' *		24F-V4 1.8E	HI-CLEAR II Treated

* 4' Increments, certain lengths are unavailable

Features & Benefits:

- Allows for a one piece install that meets code
- Can be stained any color using an oil based stain
- Helps you eliminate posts and columns, opening up lower level patios and yard space
- Easier to work with than steel - cuts, nails, and handles just like regular timber
- HiClear2 Clear treatment for above ground use.
- Custom sizes accessible
- Project pricing available

LVL SCAFFOLD PLANK



Available Sizes:

Item	SKU	Actual Size	Design Value	Unit Size	APA & OSHA Certified
LVL Scaffold Plank	916MLS	1-1/2" x 9-1/4" x 16'	2.0 E	50 pcs	Yes

Features & Benefits:

- APA & OSHA Approved
- 2.0E for safe and predictable performance
- Every piece is inspected and machine stress-rated
- End waxed and painted
- Designed for multiple uses with proper care

LSL STAIR STRINGERS AND STEPS



Available Sizes:

Item	SKU	Actual Size	Length	Max 2 Stringer Simple Span
Stair Tread	SS	1" x 11-1/2"	16'	45"
11-7/8" Stringer	11_RB	1-1/4" x 11-7/8"	16', 20'	8' - 4"
14" Stringer	1416RB	1-1/4" x 14"	16'	11' - 8"

Features & Benefits:

- The best performing stair system for quiet, sturdy, and long-lasting stairs
- Engineered wood that is perfectly straight and uniform, and will resist bowing, shrinking, and splitting
- Better nail holding capability that will eliminate squeaky stairs
- Limited product warranty

SIMPSON HANGERS

1-3/4" Width - TJI 110 Series, LVL, Timberstrand

SKU/ Model #	Description
IUS1.81/9	1-3/4"x 9-1/2" Flush Face Mount Hanger
ITS1.81/9.5	1-3/4"x 9-1/2" Top Mount Hanger
ITS1.81/11.88	1-3/4"x 11-7/8" Top Mount Hanger
IUS1.81/11.88	1-3/4"x 11-7/8" Flush Face Mount
SUR1.81/11	1-3/4"x 11-7/8" Flush Face Mount Hanger Skewed Right
SUL1.81/11	1-3/4"x 11-7/8" Flush Face Mount Hanger Skewed Left
IUS1.81/14	1-3/4"x 14" Flush Face Mount Hanger
ITS1.81/14	1-3/4"x 14" Top Mount Hanger
LSSR1.81Z	1-3/4" Adjustable Rafter Hanger

ITS/MIT Top Mount



2-1/16" - Width TJI 210 Series

ITS2.06/11.88	2-1/16"x11-7/8" Top Mount Hanger
IUS2.06	2-1/16"x11-7/8" Flush Face Mount Hanger
SUL2.1/11	2-1/16"x 11-7/8 Flush Face Mount Skewed Left 45 Deg.
SUR2.1/11	2-1/16"x 11-7/8 Flush Face Mount Skewed Right 45 Deg.
LSSU2.1	2-1/16"x 8-1/2" Slopeable/ Skewable Hanger
LSSU2.1Z	2-1/6" Adjustable Rafter Hanger
MIT4.28/11.88	4-1/8"x11-7/8" Double 210 Top Mount Hanger

IUS Face Mount



2-5/16" Width - TJI 360 Series

IUS2.37	2-5/16"x 11-7/8" Flush Face Mount Hanger
ITS2.37/11.88	2-5/16"x11-7/8" Top Mount Hanger
MIT3511.88-2	4-5/8"x11-7/8" Top mount Double Hanger
IUS2.37/14	2-5/16"x14" Flush Face Mount Hanger
ITS2.37/14	2-5/16"x 14" Top Mount Hanger
ITS2.37/16	2-5/16"x 16" Top Mount Hanger
SUR2.37/11	2-5/16"x 11-3/16" Flush Face Mount Skewed Right
SUL2.37/11	2-5/16"x 11-3/16" Flush Face Mount Skewed Left

SUL/SUR Face Mount



3-1/2" Width - TJI 560 Series, Double LVL, Timberstrand, Parallam

HHUS410	3-1/2"x 9" Flush Face Mount Hanger (up to 14")
ITS3.56/11.88	3-1/2"x11-7/8" Top Mount Hanger
IUS3.56/11.88	3-1/2"x11-7/8" Face Mount Hanger
MIT411.88	3-1/2"x11-7/8" Top Mount Hanger
MIT414	3-1/2"x14" Top Mount Hanger
MIT416	3-1/2"x 16" Top Mount Hanger
SUR410/45	3-1/2"x 8-1/2" Flush Face Mount Hanger Skewed Right
SUL410/45	3-1/2"x 8-1/2" Flush Face Mount Hanger Skewed Left

HHUS Face Mount



5-1/4" Width - Triple LVL, Parallam

HHUS5.50/10	5-1/4"x9" Flush Face Mount Hanger (up to 14")
-------------	--

Misc. Framing

A23	Angle Bracket
-----	---------------

Z-Max Post Bases

ABW66RZ	6"x6"x2-13/16" (Rough Doug Fir, Rough Cedar)
ABW66Z	5-1/2"x5-1/2"x3" (Treated, Woodtone Absolute Post, Glulam Post)
ABU88RZ	8"x7"x6-3/4" (Rough Doug Fir, Rough Cedar)
ABW7-7Z	7-5/16"x7-5/16"x3" (Treated, Woodtone Absolute Post, Glulam Post)



ABW66RZ & ABW66Z



ABU88RZ



ABW7-7Z

SPF STUDS & DIMENSIONAL LUMBER



Available Stud Sizes:

Item	Unit Size	Premium	Selects/Markets	Finger Joint
2x4x92-5/8"	294	<input checked="" type="checkbox"/>	<input checked="" type="checkbox"/>	
2x4x96"	294	<input checked="" type="checkbox"/>	<input checked="" type="checkbox"/>	
2x4x104-5/8"	294	<input checked="" type="checkbox"/>	<input checked="" type="checkbox"/>	<input checked="" type="checkbox"/>
2x4x116-5/8"	294	<input checked="" type="checkbox"/>		<input checked="" type="checkbox"/>
2x6x92-5/8"	189	<input checked="" type="checkbox"/>	<input checked="" type="checkbox"/>	
2x6x96"	189	<input checked="" type="checkbox"/>		
2x6x104-5/8"	189	<input checked="" type="checkbox"/>	<input checked="" type="checkbox"/>	
2x6x116-5/8"	189	<input checked="" type="checkbox"/>		

-Special trim sizes are available via a custom cut program at our Kansas City facility

Available Dimensional Sizes:

Item	Unit Size	Lengths	4-Square	Hiline	Dunkley/Foothills	#2&btr
2 x 4	294	8' - 20'	<input checked="" type="checkbox"/>	<input checked="" type="checkbox"/>	<input checked="" type="checkbox"/>	<input checked="" type="checkbox"/>
2 x 6	189	8' - 20'	<input checked="" type="checkbox"/>	<input checked="" type="checkbox"/>	<input checked="" type="checkbox"/>	<input checked="" type="checkbox"/>
2 x 8	147	8' - 20'				<input checked="" type="checkbox"/>

#2 KD DOUG FIR STUDS



Available Stud Sizes:

Item	Unit Size	Species	Grade	Finish
<i>2 x 4 x 104-5/8"</i>	<i>294</i>	<i>Doug Fir</i>	<i>#2&btr</i>	<i>Kiln Dried</i>
<i>2 x 4 x 116-5/8"</i>	<i>294</i>	<i>Doug Fir</i>	<i>#2&btr</i>	<i>Kiln Dried</i>
<i>2 x 6 x 104-5/8"</i>	<i>189</i>	<i>Doug Fir</i>	<i>#2&btr</i>	<i>Kiln Dried</i>
<i>2 x 6 x 116-5/8"</i>	<i>189</i>	<i>Doug Fir</i>	<i>#2&btr</i>	<i>Kiln Dried</i>

Features & Benefits:

- Kiln Dried
- #2 Grade Stamp
- Higher compression value than SPF, matching Yellow Pine
- More straight and predictable than Yellow Pine
- Excellent for commercial and multi-family construction

YELLOW PINE DIMENSION LUMBER



Available Sizes:

Item	Unit Size	Lengths	#1 YP	#2 YP	MSR 2400
2 x 4	208	8' - 20'	<input checked="" type="checkbox"/>	<input checked="" type="checkbox"/>	<input checked="" type="checkbox"/>
2 x 6	128	8' - 20'	<input checked="" type="checkbox"/>	<input checked="" type="checkbox"/>	<input checked="" type="checkbox"/>
2 x 8	96	8' - 20'	<input checked="" type="checkbox"/>	<input checked="" type="checkbox"/>	<input checked="" type="checkbox"/>
2 x 10	80	8' - 20'	<input checked="" type="checkbox"/>	<input checked="" type="checkbox"/>	<input checked="" type="checkbox"/>
2 x 12	64	8' - 20'	<input checked="" type="checkbox"/>		<input checked="" type="checkbox"/>
4 x 4	52	8', 12', 16'		<input checked="" type="checkbox"/>	

Features & Benefits:

- Superior strength to SPF and Douglas Fir; excellent for floor joist and roof trusses
- We carry the deepest inventory of MSR 2400 Yellow Pine
- Contact us for mill direct quotes

4X4 TIMBERS



Available Sizes:

Item	Actual Size	Lengths	Grade	Finish	HT Stamp
4x4 Yellow Pine	3-1/2" x 3-1/2"	8' - 16'	#2	KD S4S	Yes
4x4 Douglas Fir	4" x 4"	8' - 12'	#1 FOHC	Green	No

Features & Benefits:

- Untreated 4x4 Timbers
- #2 SYP is KDHT and is great for crating, cribbing, and other industrial applications

LONG LENGTH DOUGLAS FIR



Available Sizes:

Item	Lengths	Unit Size	Grade	Finish	Species
2 x 6	22' - 28'	189	#2&btr	Kiln Dried	Douglas Fir
2 x 8	22' - 28'	126	#2&btr	Kiln Dried	Douglas Fir
2 x 10	22' - 28'	105	#2&btr	Kiln Dried	Douglas Fir
2 x 12	22' - 28'	84	#2&btr	Kiln Dried	Douglas Fir

Features & Benefits:

- Available in less than unit quantities
- Our longest available solid sawn material
- Excellent for roof rafters or long floor joists

MCA TREATED LUMBER



Available Sizes:

Item	Grade	Lengths	Treatment	Color	Unit Size
2 x 4	#1 Yellow Pine	8' - 16'	MCA Ground Contact	Green	104
2 x 6	#1 Yellow Pine	8' - 20'	MCA Ground Contact	Green	64
2 x 8	#1 Yellow Pine	8' - 20'	MCA Ground Contact	Green	48
2 x 10	#1 Yellow Pine	8' - 20'	MCA Ground Contact	Green	40
2 x 12	#1 Yellow Pine	8' - 20'	MCA Ground Contact	Green	32
5/4 x 6	Standard	8' - 20'	MCA Ground Contact	Green	96
5/4 x 6	Premium	10' - 16'	MCA Ground Contact	Green	96
4 x 4	#2 Yellow Pine	8' - 10'	MCA Ground Contact	Green	52
6 x 6	#2 Yellow Pine	8' - 16'	MCA Ground Contact	Green	32

Features & Benefits:

- Available in less than unit and job-pack quantities
- All MCA treated lumber is a .15 MCA Ground Contact treatment
- Light green treatment that naturally fades with time

CCA TREATED TIMBERS



Available Sizes:

Item	SKU	Lengths	Unit Size	Grade	Treatment
4 x 4 Treated	44_T2	8' - 16'	65	#2&btr SYP	.60 CCA Ground Contact
4 x 6 Treated	46_T2	8' - 20'	48	#2&btr SYP	.60 CCA Ground Contact
6 x 6 Treated	66_T2	8' - 24'	32	#2&btr SYP	.60 CCA Ground Contact
8 x 8 Treated	88_T2	8' - 20'	18	#2&btr SYP	.60 CCA Ground Contact

Features & Benefits:

- Strong .60 CCA Ground Contact treatment to prevent rot and decay
- A true #2&btr grade with ~30% meeting a #1 grade
- Very high quality with four square edges and extremely limited splits
- Available in less than unit and job-pack quantities
- Custom sizes available on a special-order basis

BIG V TONGUE & GROOVE TREATED



Item	Grade	Lengths	Treatment	Color	Unit Size
2 x 6 T&G	#1 Yellow Pine	12' & 16'	MCA Ground Contact	Green	64
2 x 8 T&G	#1 Yellow Pine	12' & 16'	MCA Ground Contact	Green	48

-Big V T&G allows boards to slide into place seamlessly despite any crook or bow

TREATED BOARDS, SPINDLES, FENCING



Item	Grade	Lengths	Treatment	Color	Unit Size
1 x 6 Boards	#2 Yellow Pine	8', 12', 16'	MCA Ground Contact	Green	128
1 x 8 Boards	#2 Yellow Pine	12', 16'	MCA Ground Contact	Green	80
2 x 2 Spindles	#1 Yellow Pine	42", 8'	MCA Ground Contact	Green	360/192
1 x 6 Dog Ear	#2 Yellow Pine	6', 8'	MCA Ground Contact	Green	240
3 x 5 Landscape Timbers	#2 Yellow Pine	8'	MCA Ground Contact	Green	77

FIRE TREATED LUMBER



LUMBER

Available Sizes:

Interior Fire Treated

Item	SKU	Lengths	Grade	Application
<i>2 x 4 Interior Fire Treated</i>	<i>24_FT2</i>	<i>8', 10', 12', 16'</i>	<i>#2 Yellow Pine</i>	<i>Interior</i>
<i>2 x 6 Interior Fire Treated</i>	<i>26_FT2</i>	<i>8', 12', 16'</i>	<i>#2 Yellow Pine</i>	<i>Interior</i>
<i>2 x 8 Interior Fire Treated</i>	<i>28_FT2</i>	<i>12', 16'</i>	<i>#2 Yellow Pine</i>	<i>Interior</i>
<i>2 x 10 Interior Fire Treated</i>	<i>210_FT2</i>	<i>12', 16'</i>	<i>#2 Yellow Pine</i>	<i>Interior</i>
<i>2 x 12 Interior Fire Treated</i>	<i>212_FT2</i>	<i>12', 16'</i>	<i>#2 Yellow Pine</i>	<i>Interior</i>

Exterior Fire Treated

Item	SKU	Lengths	Grade	Application
<i>2 x 4 Exterior Fire Treated</i>	<i>24_FTX2</i>	<i>12', 16'</i>	<i>#2 Yellow Pine</i>	<i>Exterior</i>
<i>2 x 6 Exterior Fire Treated</i>	<i>26_FTX2</i>	<i>12', 16'</i>	<i>#2 Yellow Pine</i>	<i>Exterior</i>
<i>2 x 8 Exterior Fire Treated</i>	<i>28_FTX2</i>	<i>16'</i>	<i>#2 Yellow Pine</i>	<i>Exterior</i>
<i>2 x 10 Exterior Fire Treated</i>	<i>210_FTX2</i>	<i>12', 16'</i>	<i>#2 Yellow Pine</i>	<i>Exterior</i>
<i>2 x 12 Exterior Fire Treated</i>	<i>212_FTX2</i>	<i>12', 16'</i>	<i>#2 Yellow Pine</i>	<i>Exterior</i>

Features & Benefits:

- Available in both Interior and Exterior fire treated
- Fully pressure impregnated treatment; no surface coatings
- All boards are individually stamped with fire treatment and rating

PREMIUM FURRING STRIPS



1x2x8



1x3x8



2x2x8

Available Sizes:

Item	Actual Size	Unit Size	Species	Sub-Bundled	End Paint
<i>1x2x8</i>	<i>3/4" x 1-1/2"</i>	<i>648</i>	<i>SPF</i>	<i>Yes (12pcs)</i>	<i>Yes</i>
<i>1x3x8</i>	<i>3/4" x 2-1/2"</i>	<i>480</i>	<i>SPF</i>	<i>Yes (12pcs)</i>	<i>Yes</i>
<i>2x2x8</i>	<i>1-1/2" x 1-1/2"</i>	<i>420</i>	<i>SPF</i>	<i>Yes (12pcs)</i>	<i>Yes</i>

Features & Benefits:

- Available in full units or half packs
- Premium grade with virtually no bark or wane
- Paper wrapped and sub-bundled
- Special order sizes and cuts are available in full unit quantities

YELLOW PINE BULLNOSE STAIR TREAD



Available Size:

Item	Actual Size	Length	Unit Size	Grade
<i>2 x 12 Bullnose</i>	<i>1-1/2" x 11-1/4"</i>	<i>14'</i>	<i>64</i>	<i>#1 Yellow Pine</i>

Features & Benefits:

- #1 Yellow Pine
- 14' Material
- Can be installed during framing
- A full 1-1/2" thick
- Can be stained and left exposed or covered with carpet to fit any household style
- Available by the unit or by the piece



OSB PANELS



Available Sizes:

Item	Dimension	Unit Size	Rating
<i>1/4" Southern</i>	<i>4' x 8'</i>	<i>140</i>	<i>Exposure 1</i>
<i>7/16" Southern</i>	<i>4' x 8'</i>	<i>85</i>	<i>Exposure 1</i>
<i>7/16" Northern</i>	<i>4' x 8'</i>	<i>78</i>	<i>Exposure 1</i>
<i>7/16" No Paint</i>	<i>4' x 8'</i>	<i>85</i>	<i>-</i>
<i>7/16" Radiant Barrier</i>	<i>4' x 8'</i>	<i>78</i>	<i>Exposure 1</i>
<i>7/16" 9' Southern</i>	<i>4' x 9'</i>	<i>82</i>	<i>Exposure 1</i>
<i>7/16" 10' Southern</i>	<i>4' x 10'</i>	<i>87</i>	<i>Exposure 1</i>
<i>7/16" 9' Northern</i>	<i>4' x 9'</i>	<i>78</i>	<i>Exposure 1</i>
<i>15/32" Southern</i>	<i>4' x 8'</i>	<i>72</i>	<i>Exposure 1</i>
<i>15/32" Radiant Barrier</i>	<i>4' x 8'</i>	<i>72</i>	<i>Exposure 1</i>
<i>1/2" Southern</i>	<i>4' x 8'</i>	<i>70</i>	<i>Exposure 1</i>
<i>1/2" Northern</i>	<i>4' x 8'</i>	<i>68</i>	<i>Exposure 1</i>
<i>1/2" Struc-1</i>	<i>4' x 8'</i>	<i>68</i>	<i>Struc-1</i>
<i>19/32" Southern</i>	<i>4' x 8'</i>	<i>63</i>	<i>Exposure 1</i>
<i>5/8" Northern</i>	<i>4' x 8'</i>	<i>54</i>	<i>Exposure 1</i>
<i>5/8" Struc-1</i>	<i>4' x 8'</i>	<i>54</i>	<i>Struc-1</i>
<i>3/4" Square Edge</i>	<i>4' x 8'</i>	<i>48</i>	<i>Exposure 1</i>
<i>3/4" Edge T&G</i>	<i>4' x 8'</i>	<i>48</i>	<i>Exposure 1</i>
<i>3/4" Edge Gold T&G</i>	<i>4' x 8'</i>	<i>48</i>	<i>Exposure 1</i>
<i>3/4" Advantech T&G</i>	<i>4' x 8'</i>	<i>45</i>	<i>Exposure 1</i>
<i>1-1/8" Advantech T&G</i>	<i>4' x 8'</i>	<i>30</i>	<i>Exposure 1</i>

EDGE GOLD T&G SUBFLOOR



PANELS

Available Sizes:

Item	Panel Size	Unit Size	Fastner Grid	Drainage System
3/4" T&G	4' x 8'	48 pcs	Yes	Yes

Special Order:

7/8" T&G	4' x 8'	39 pcs	Yes	Yes
1-1/8" T&G	4' x 8'	30 pcs	Yes	Yes

Features & Benefits:

- Pound for pound the best bang for your buck in sub-flooring
- 50 Year Warranty and a 200 day no-sand guarantee
- Down Pore Drainage System ensures that water properly drains, protecting against edge swell and sanding before installing hardwood flooring or tile
- Fastener Grid that ships face-up, ready for easy and accurate installation
- Roughly 20% less than the cost of Advantech

ADVANTECH T&G SUBFLOOR



Available Sizes:

Item	Panel Size	Unit Size	PS2 Span	Fastener Grid
3/4" T&G	4' x 8'	45	24" O.C.	Yes
1-1/8" T&G	4' x 8'	30	48" O.C.	Yes
Special Order:				
19/32" T&G	4' x 8'	55	20" O.C.	Yes
7/8" T&G	4' x 8'	40	32" O.C.	Yes

Features & Benefits:

- The #1 ranked sub-floor product for over a decade
- Lifetime warranty and a 500-day no-sand guarantee
- Three times the bending strength of commodity OSB for superior stiffness and reliability
- A built-in 1/8" gap between each panel for proper spacing

ZIP SYSTEM SHEATHING



Available Sizes:

Item	SKU	Panel Size	Unit Size	Color	Rating
7/16" - 4x8	7168Z	4' x 8'	80	Green	Struc - 1
7/16" - 4x9	7169Z	4' x 9'	70	Green	Struc - 1
7/16" - 4x10	71610Z	4' x 10'	60	Green	Struc - 1
1/2" - 4x8	128Z	4' x 8'	70	Red	Struc - 1
1/2" - 4x9	129Z	4' x 9'	62	Red	Struc - 1
1/2" - 4x10	1210Z	4' x 10'	56	Red	Struc - 1
5/8" - 4x8	588Z	4' x 8'	55	Red	Struc - 1

Features & Benefits:

- Engineered with a built-in water and energy barrier
- Installs 40% faster than traditional OSB with housewrap
- Roughly \$190 in annual heating and cooling savings in the St. Louis area for an average sized home versus traditional OSB with housewrap
- All panels are Struc-1 Rated

ZIP SYSTEM R-SHEATHING

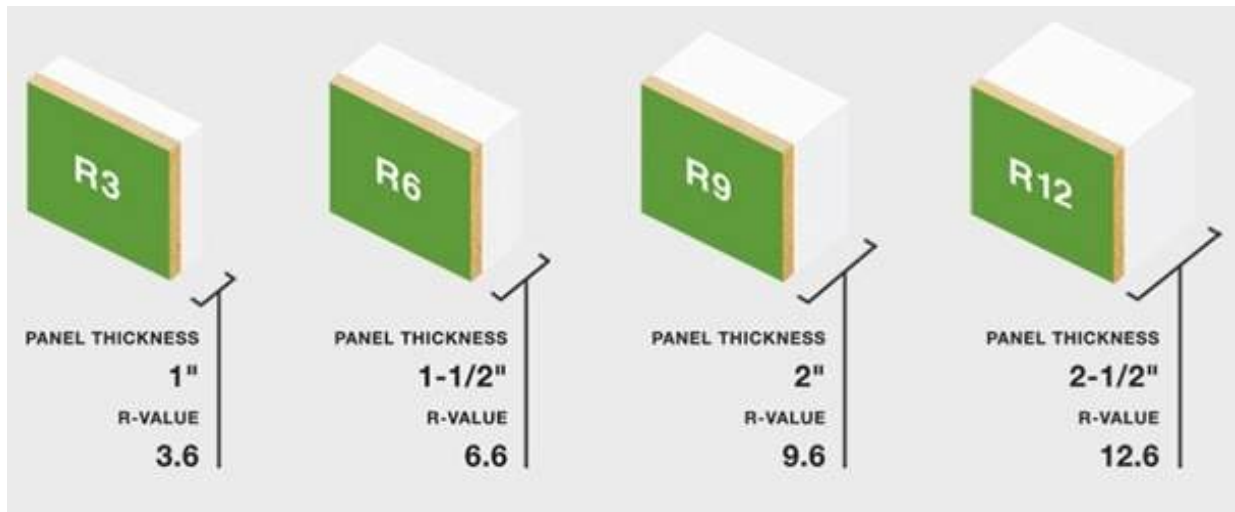

Available Sizes:

Item	SKU	Panel Size	Unit Size	R-Rating
7/16" R3.6	15168Z	4' x 8'	32	0.5" Foam R-3.6
7/16" R6.6	17168Z	4' x 8'	31	1" Foam R-6.6
7/16" R9.6	R97168Z	4' x 8'	23	1.5" Foam R-9.6
7/16" R12.6	R127168Z	4' x 8'	18	2" Foam R-12.6

Features & Benefits

- Engineered with a built-in water and energy barrier for great thermal efficiency
- A one-piece panel for easy installation
- All panels are Struc-1 Rated

ADVANTECH SUB-FLOOR ADHESIVE



PANELS



AdvanTech™ Subfloor Adhesive
(6 cans/case)



AdvanTech™ Subfloor Adhesive Cleaner
(6 cans/case)



AdvanTech™ Pro-Grade Foam Applicator Gun
(4 guns/case)



AdvanTech™ Subfloor Adhesive Starter Kit
(1 starter kit = 6 cans adhesive,
1 can cleaner, 1 gun)

Features & Benefits:

- More cost-effective than traditional sub-floor adhesive
- 400 Lineal Foot of coverage per can (16 4x8 sheets)
- 10 Year Squeak-Free Guarantee when used with TJI Engineered Joists and Advantech T&G Sub-Floor
- Can be installed in extreme temperature ranges; adheres to wet or frozen wood
- Low odor & limited mess

ZIP TAPE & FLASHING



SKU	Item Description	Unit of Sale
430ZT	4" x 30' Zip Tape	1 Roll
4ZT	4" x 90' Zip Tape	12 Rolls
6ZT	6" x 90' Zip Tape	4 Rolls
950ZT	9" x 50' Zip Tape	1 Roll
1250ZT	12" x 50' Zip Tape	1 Roll
320ZST	3" x 20' Zip *Stretch* Tape	1 Roll
620ZST	6" x 20' Zip *Stretch* Tape	1 Roll
6ZST	6" x 75' Zip *Stretch* Tape	1 Roll
1020ZST	10" x 20' Zip *Stretch* Tape	1 Roll
10ZST	10" x 75' Zip *Stretch* Tape	1 Roll
ZTG	Zip Tape Gun	1 Gun
ZTR	Zip Tape Roller	1 Roller
29ZLF	29 Ounce Zip Liquid Flash	1 Cartridge

4" Zip Tape Coverage
One 90' roll will cover seven panels on average

Features & Benefits:

- Zip System yields an estimated 11% annual heating and cooling savings in the St. Louis market compared to a traditional house wrapped home
- Tape can be applied in wet and dry conditions
- 30 year warranty with an allowable 180 day sun exposure
- Incredibly versatile, and can be used for corners, valleys, window flashing, sills, ridges, and more

ZIP PEEL & STICK UNDERLAYMENT

PANELS



Available Sizes:

Item	Type	SKU	Actual Size	Coverage
<i>Zip Peel and Stick Underlayment</i>	<i>Standard</i>	<i>ZPS</i>	<i>3' x 66'</i>	<i>200 Sq Ft</i>
<i>Zip Peel and Stick Underlayment</i>	<i>High Temperature</i>	<i>ZPSHT</i>	<i>3' x 66'</i>	<i>200 Sq Ft</i>

Features & Benefits:

- Use to meet code requirements for ice barrier or as a waterproofing roofing underlayment
- High-performance self-adhered rubberized asphalt product that seals around nails
- Protect areas at risk of leaks or water damage due to ice dams or wind-driven rain, such as at eaves and valleys, or entire roof application
- Slip-resistant surface for ease of application
- Leak-free Guarantee

ZIP RAINSCREEN



Available Size:

Item	SKU	Actual Size	Coverage
<i>Zip Rainscreen</i>	ZRAIN	1/4" x 4' x 65'	260 Sq Ft

Features & Benefits

- Creates a 1/4" drainage and air gap to promote better drying within the wall assembly
- Integrated second layer of water-resistance
- 90-day exposure warranty
- Great for use with stucco, adhered stone, brick veneer, fiber cement, and wood siding

FIR PLYWOOD



Available Sizes:

Item	Thickness	Panel Size	Unit Size	Species
<i>3/8" CDX</i>	<i>11/32"</i>	<i>4' x 8'</i>	<i>90</i>	<i>Douglas Fir</i>
<i>1/2" CDX 4-Ply</i>	<i>15/32"</i>	<i>4' x 8'</i>	<i>66</i>	<i>Douglas Fir</i>
<i>1/2" CDX 5-Ply</i>	<i>15/32"</i>	<i>4' x 8'</i>	<i>66</i>	<i>Douglas Fir</i>
<i>5/8" CDX 4-Ply</i>	<i>19/32"</i>	<i>4' x 8'</i>	<i>53</i>	<i>Douglas Fir</i>
<i>5/8" CDX 5-Ply</i>	<i>19/32"</i>	<i>4' x 8'</i>	<i>53</i>	<i>Douglas Fir</i>
<i>3/4" CDX</i>	<i>23/32"</i>	<i>4' x 8'</i>	<i>44</i>	<i>Douglas Fir</i>
<i>1" CDX</i>	<i>31/32"</i>	<i>4' x 8'</i>	<i>33</i>	<i>Douglas Fir</i>
<i>3/4" CD T&G</i>	<i>23/32"</i>	<i>4' x 8'</i>	<i>44</i>	<i>Douglas Fir</i>
<i>3/4" Sturd-I-Floor T&G</i>	<i>23/32"</i>	<i>4' x 8'</i>	<i>44</i>	<i>Douglas Fir</i>
<i>3/4" BB Plyform</i>	<i>23/32"</i>	<i>4' x 8'</i>	<i>44</i>	<i>Douglas Fir</i>
<i>1/2" ACX</i>	<i>15/32"</i>	<i>4' x 8'</i>	<i>66</i>	<i>Douglas Fir</i>
<i>1/2" AB Marine</i>	<i>15/32"</i>	<i>4' x 8'</i>	<i>66</i>	<i>Douglas Fir</i>
<i>3/4" ACX</i>	<i>23/32"</i>	<i>4' x 8'</i>	<i>44</i>	<i>Douglas Fir</i>
<i>3/4" AB Marine</i>	<i>23/32"</i>	<i>4' x 8'</i>	<i>44</i>	<i>Douglas Fir</i>

Features & Benefits:

- Generally, less susceptible to warping and delamination than Yellow Pine
- Strong, stiff, and durable – excellent for roof sheathing or T&G subfloor

MDO & HDO PLYWOOD



Available Sizes:

Item	Thickness	Panel Size	Unit Size	Species
<i>1/2" MDO 1 Side</i>	<i>15/32"</i>	<i>4' x 8'</i>	<i>66</i>	<i>Douglas Fir</i>
<i>1/2" MDO 2 Side</i>	<i>15/32"</i>	<i>4' x 8'</i>	<i>66</i>	<i>Douglas Fir</i>
<i>3/4" MDO 1 Side</i>	<i>23/32"</i>	<i>4' x 8'</i>	<i>44</i>	<i>Douglas Fir</i>
<i>3/4" MDO 2 Side</i>	<i>23/32"</i>	<i>4' x 8'</i>	<i>44</i>	<i>Douglas Fir</i>
<i>1/2" HDO 1 Side</i>	<i>15/32"</i>	<i>4' x 8'</i>	<i>66</i>	<i>Douglas Fir</i>
<i>3/4" HDO 1 Side</i>	<i>23/32"</i>	<i>4' x 8'</i>	<i>44</i>	<i>Douglas Fir</i>

Features & Benefits:

- MDO panels have a cardboard like fiber overlay that takes paint exceptionally well
- MDO panels are commonly used for exterior signs
- HDO panels have an extremely tough and durable resin impregnated fiber face
- HDO panels are excellent for concrete forming and industrial applications with frequent chemical or gas contact
- All MDO and HDO panels contain 100% water resistant adhesives

YELLOW PINE PLYWOOD



PANELS

Available Sizes:

Item	Thickness	Size	Unit Size	Species
<i>3/8" Rated Sheathing</i>	<i>11/32"</i>	<i>4' x 8'</i>	<i>90</i>	<i>Yellow Pine</i>
<i>1/2" 4-Ply Rated Sheathing</i>	<i>15/32"</i>	<i>4' x 8'</i>	<i>70</i>	<i>Yellow Pine</i>
<i>5/8" 4-Ply Rated Sheathing</i>	<i>19/32"</i>	<i>4' x 8'</i>	<i>56</i>	<i>Yellow Pine</i>
<i>3/4" Rated Sheathing</i>	<i>23/32"</i>	<i>4' x 8'</i>	<i>48</i>	<i>Yellow Pine</i>
<i>3/4" SIF T&G Subfloor</i>	<i>23/32"</i>	<i>4' x 8'</i>	<i>48</i>	<i>Yellow Pine</i>
<i>1/2" Struc 1 Ply</i>	<i>15/32"</i>	<i>4' x 8'</i>	<i>70</i>	<i>Yellow Pine</i>
<i>5/8" Struc 1 Ply</i>	<i>19/32"</i>	<i>4' x 8'</i>	<i>56</i>	<i>Yellow Pine</i>
<i>3/4" Struc 1 Ply</i>	<i>23/32"</i>	<i>4' x 8'</i>	<i>48</i>	<i>Yellow Pine</i>
<i>3/4" BBOES Plyform</i>	<i>23/32"</i>	<i>4' x 8'</i>	<i>48</i>	<i>Pine</i>

Features & Benefits:

- Premium mill quality
- GP, Hunt, and Weyerhaeuser stock
- Mill direct quotes available

YELLOW PINE INDUSTRIAL SELECT GRADE PLYWOOD



Available Sizes:

Item	Actual Size	Unit Size	Species	Grade
<i>3/8" Select Ply</i>	<i>11/32" 4' x 8'</i>	<i>90</i>	<i>Yellow Pine</i>	<i>Select</i>
<i>1/2" Select Ply</i>	<i>15/32" 4' x 8'</i>	<i>72</i>	<i>Yellow Pine</i>	<i>Select</i>
<i>5/8" Select Ply</i>	<i>19/32" 4' x 8'</i>	<i>58</i>	<i>Yellow Pine</i>	<i>Select</i>
<i>3/4" Select Ply</i>	<i>23/32" 4' x 8'</i>	<i>48</i>	<i>Yellow Pine</i>	<i>Select</i>

Features & Benefits:

- Downfall Industrial grade plywood that has been manually re-sorted to pull out the best quality
- Great overall value - priced roughly 15-20% less than regular rated sheathing
- Excellent option for packaging, crating, boxing, bins, plyform, simple construction, and other industrial applications
- All panels will be within tolerance on thickness and have four good square edges

SANDED PLYWOOD

AC Radiata



BC Yellow Pine



Available Sizes:

Item	Thickness	Size	Unit Size	Species	Grade
3/8" BC	11/32"	4' x 8'	45	Yellow Pine	BC
1/2" BC	15/32"	4' x 8'	36	Yellow Pine	BC
5/8" BC	19/32"	4' x 8'	29	Yellow Pine	BC
3/4" BC	23/32"	4' x 8'	24	Yellow Pine	BC
1/4" AC Radiata	1/4"	4' x 8'	160	Radiata Pine	AC
3/8" AC Radiata	11/32"	4' x 8'	108	Radiata Pine	AC
1/2" AC Radiata	15/32"	4' x 8'	80	Radiata Pine	AC
5/8" AC Radiata	19/32"	4' x 8'	65	Radiata Pine	AC
3/4" AC Radiata	23/32"	4' x 8'	54	Radiata Pine	AC
1" AC Radiata	31/32"	4' x 8'	39	Radiata Pine	AC
1/2" AC Fir	15/32"	4' x 8'	66	Douglas Fir	AC
3/4" AC Fir	23/32"	4' x 8'	44	Douglas Fir	AC

Features & Benefits:

- Excellent for painting and finished work like cabinetry and shelving
- Available in less than unit quantities

PINE PLYWOOD SIDING

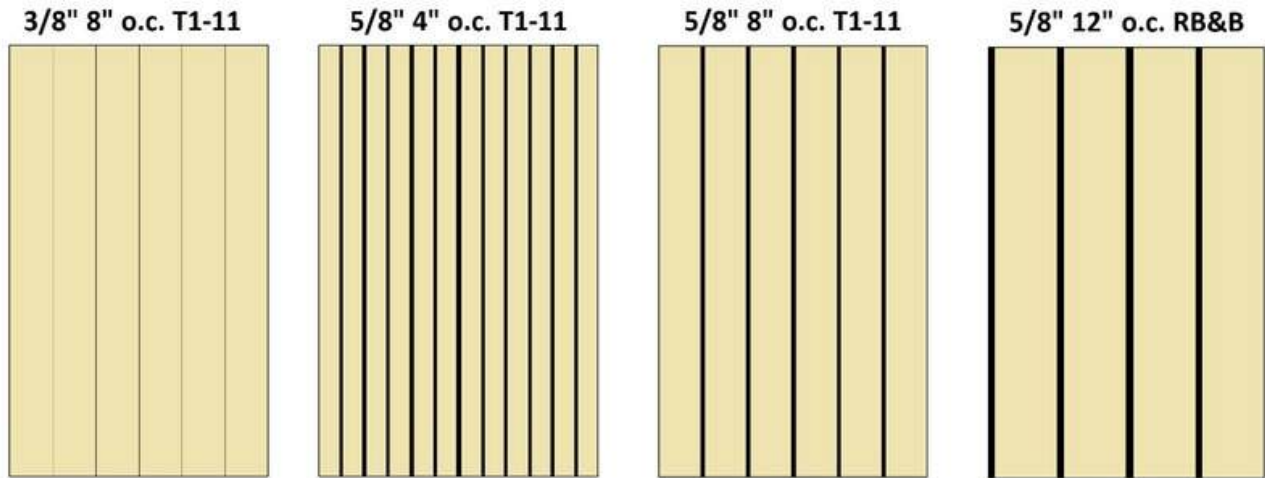

Available Sizes:

Item	Thickness	Size	Unit Size	Species	Grade
<i>3/8" 2" o.c. Beadboard</i>	<i>11/32"</i>	<i>4' x 8'</i>	<i>108</i>	<i>Radiata Pine</i>	<i>Premium</i>
<i>3/8" 8" o.c. T1-11</i>	<i>11/32"</i>	<i>4' x 8'</i>	<i>90</i>	<i>Pine</i>	<i>Premium & Deco</i>
<i>5/8" 4" o.c. T1-11</i>	<i>19/32"</i>	<i>4' x 8'</i>	<i>58</i>	<i>Pine</i>	<i>Premium & Deco</i>
<i>5/8" 8" o.c. T1-11</i>	<i>19/32"</i>	<i>4' x 8'</i>	<i>58</i>	<i>Pine</i>	<i>Premium & Deco</i>
<i>5/8" 12" o.c. RB&B</i>	<i>19/32"</i>	<i>4' x 8'</i>	<i>58</i>	<i>Pine</i>	<i>Premium & Deco</i>

Features & Benefits:

- Easy to install shiplap panels
- Fully approved for exterior siding
- Available in both a premium and deco grade, and less than unit quantities
- Premium will have six repair patches or less and can be either painted or stained.
- Deco grade has no limit on repair patches and will use a glue adhesive to fill gaps, holes, and voids. It is generally intended to be painted.

PRESSURE TREATED PLYWOOD



PANELS

Available Sizes:

Item	Actual Thickness	Panel Size	Unit Size
<i>1/2" Treated</i>	<i>15/32"</i>	<i>4' x 8'</i>	<i>70</i>
<i>5/8" Treated</i>	<i>19/32"</i>	<i>4' x 8'</i>	<i>58</i>
<i>3/4" Treated</i>	<i>23/32"</i>	<i>4' x 8'</i>	<i>46</i>

Features & Benefits:

- Premium MCA Treatment
- Prevents rot and decay
- Excellent for exterior or moist and damp applications
- Available in less than unit quantities

FIRE TREATED PLYWOOD



PYRO-GUARD®

EXTERIOR FIRE-X®

Available Sizes:

Item	Application	Panel Size	Treatment	Edge Profile
1/2" CD	Interior	4' x 8'	Fire-Retardant	Square Edge
5/8" CD	Interior	4' x 8'	Fire-Retardant	Square Edge
3/4" CD	Interior	4' x 8'	Fire-Retardant	Square Edge
3/4" AC	Interior	4' x 8'	Fire-Retardant	Square Edge
3/4" SIF T&G	Interior	4' x 8'	Fire-Retardant	Tongue & Groove
1/2" CD	Exterior	4' x 8'	Fire-Retardant	Square Edge
5/8" CD	Exterior	4' x 8'	Fire-Retardant	Square Edge
3/4" CD	Exterior	4' x 8'	Fire-Retardant	Square Edge

Features & Benefits:

- Fully pressure impregnated treatment, no top-coatings or false protection
- Class A Fire Treated
- When exposed to fire, non-combustible gas and water vapor are produced and a layer of protective char forms

MDF / HARDBOARD PANELS



PANELS

Available Sizes:

Item	Actual Size	Unit Size	Finish	Moisture Content
1/4" MDF	1/4" x 49" x 97"	96	Raw MDF	4-6%
3/8" MDF	3/8" x 49" x 97"	60	Raw MDF	4-6%
5/8" MDF	5/8" x 49" x 97"	48	Raw MDF	4-6%
1/2" MDF	1/2" x 49" x 97"	48	Raw MDF	4-6%
3/4" MDF	3/4" x 49" x 97"	30	Raw MDF	4-6%

Features & Benefits:

- Premium MDF panels manufactured to exacting standards
- Commonly used for furniture, cabinets, door parts, store fixtures, toys & musical instruments
- Can be routed, cut, and ripped to size
- Perfectly flat surface that takes paint extremely well

Item	Actual Size	Unit Size
Lauan Plywood	4' x 8'	115



eucatex 

Item	Actual Size	Brand	Unit Size
Tempered Hardboard G1S (1 side)	1/8" x 4' x 8'	Eucatex	50 pcs

EXACOR PANELS



Available Sizes:

Item	Thickness	Panel Size	Pieces/Unit	Weight/Panel	Application
<i>1/2" 4 x 8 Exacor</i>	<i>1/2"</i>	<i>48" x 96"</i>	<i>38</i>	<i>88 LBS</i>	<i>Underlayment/Sheathing</i>

Special Order:

Item	Thickness	Panel Size	Pieces/Unit	Weight/Panel	Application
<i>5/8" 4 x 8 Exacor</i>	<i>5/8"</i>	<i>48" x 96"</i>	<i>28</i>	<i>118 LBS</i>	<i>Exterior Sheathing</i>
<i>5/8" 4 x 9 Exacor</i>	<i>5/8"</i>	<i>48" x 108"</i>	<i>25</i>	<i>133 LBS</i>	<i>Exterior Sheathing</i>
<i>5/8" 4 x 10 Exacor</i>	<i>5/8"</i>	<i>48" x 120"</i>	<i>24</i>	<i>147 LBS</i>	<i>Exterior Sheathing</i>
<i>1/2" 4 x 9 Exacor</i>	<i>1/2"</i>	<i>48" x 108"</i>	<i>33</i>	<i>99 LBS</i>	<i>Exterior Sheathing</i>
<i>1/2" 4 x 10 Exacor</i>	<i>1/2"</i>	<i>48" x 120"</i>	<i>32</i>	<i>110 LBS</i>	<i>Exterior Sheathing</i>

Features & Benefits:

Underlayment

- Speeds up construction time by two full weeks
- Works better for high humidity environments, such as St. Louis
- Streamlined ordering process
- Major jobsite storage improvements

Exterior Sheathing

- Meets fire code requirements
- Streamlined ordering process
- Available in 9' and 10' panels
- Can be pre-assembled on wall panels for panelized construction

BOARDS AND PATTERN STOCK

We've developed a portfolio of high-quality boards and pattern stock that are well designed, affordable, and easy to sell.

The WynnWood Boards and Pattern Stock Advantage

- Premium Canadian ESLP that supersedes standard #2 grading rules
- A 1/16th micro-eased edge on all S4S boards, and the highest quality finish of any board or pattern stock in North America
- Convenient unit sizes and excellent packaging and sub-bundling
- The widest mix of available product and pattern for any conceivable project



Boards

- Premium #2 Canfor Wynnwood Premier
- Clear Finger Jointed Double Primed Radiata Pine



Nickel Gap/V-Groove

- Premium #2 WynnWood Premier
- Clear Finger Jointed Double Primed Radiata Pine



Carsiding

- Premium #2 WynnWood Premier and #3 Rustic Classic
- 1x6 and 1x8 (8' - 16')



Beaded

- Premium #2 WynnWood Premier
- 1x4 (12' & 16')

CANFOR WYNNWOOD BOARDS



WYNNWOOD PREMIER

SPECIES: ESLP GRADE STAMP: 2COM & BTR
MOISTURE RATING: KD-HT

THIS IS OUR HIGH LINE 2 COM & BTR GRADE.
WHEN COMPARED TO NLGA 2 COM & BTR, WYNNWOOD PREMIER HAS:

95% WANE FREE | 90% STAIN FREE | 50% LESS TOTAL SPLIT LENGTH



Available Sizes:

Item	Lengths	Unit Size	Grade	Finish	Species
1 x 4	8' - 16'	280	#2 Premier	S4S Eased Edge	ESLP
1 x 6	8' - 16'	180	#2 Premier	S4S Eased Edge	ESLP
1 x 8	8' - 16'	140	#2 Premier	S4S Eased Edge	ESLP
1 x 10	8' - 16'	100	#2 Premier	S4S Eased Edge	ESLP
1 x 12	8' - 16'	80	#2 Premier	S4S Eased Edge	ESLP

Features & Benefits:

- The highest quality finish of any board in North America
- Engelmann Spruce and Lodgepole Pine mix; small and limited knot structure
- Supersedes NLGA or WWPA grades with 50% less wane, almost no blue stain and strict limits on end splits.
- Micro-eased 1/16th-inch radius edge
- All boards are end waxed and stamped KDHT

PRIMED FINGER JOINT RADIATA PINE



BOARDS

Available Sizes:

Item	Actual Size	Lengths	Unit Sizes		Species	Grade	Finish
			Master Pack	Sub Pack			
1 x 4 S4S	23/32" x 3-1/2"	16'	456	228	Radiata Pine	Clear FJ	Gesso Primed
1 x 6 S4S	23/32" x 5-1/2"	16'	266	133	Radiata Pine	Clear FJ	Gesso Primed
1 x 8 S4S	23/32" x 7-1/4"	16'	228	114	Radiata Pine	Clear FJ	Gesso Primed
1 x 10 S4S	23/32" x 9-1/4"	16'	152	76	Radiata Pine	Clear FJ	Gesso Primed
1 x 12 S4S	23/32" x 11-1/4"	16'	152	76	Radiata Pine	Clear FJ	Gesso Primed
5/4 x 6 S4S	31/32" x 5-1/2"	16'	42	-	Radiata Pine	Clear FJ	Acrylic Primed
5/4 x 8 S4S	31/32" x 7-1/4"	16'	36	-	Radiata Pine	Clear FJ	Acrylic Primed
5/4 x 12 S4S	31/32" x 11-1/4"	16'	24	-	Radiata Pine	Clear FJ	Acrylic Primed

Features & Benefits:

- Premium Imported Radiata Pine
- 100% clear finger-jointed blocks
- Double primed boards featuring a thick gesso primer
- Excellent for interior trim
- One year warranty on primer, 10 year on substrate glue

#2 COMMON PINE BOARDS

Available Sizes:

Item	Lengths	Unit Size	Grade	Species	Finish	KDHT
1 x 4	8' - 16'	192	#2 Common	Ponderosa Pine	S4S, Square Edge	Yes
1 x 6	8' - 16'	128	#2 Common	Ponderosa Pine	S4S, Square Edge	Yes
1 x 8	8' - 16'	96	#2 Common	Ponderosa Pine	S4S, Square Edge	Yes

Features & Benefits:

- 100% Ponderosa Pine
- Half packs for easy storage
- Square edge boards
- KDHT stamped



#3 COMMON PINE BOARDS



Available Sizes:

Item	Lengths	Unit Size (Varies)	Grade	Species	KDHT Stamp
1 x 4	8' - 16'	~416	#3	PPLP/ESLP	Yes
1 x 6	8' - 16'	~256	#3	PPLP/ESLP	Yes
1 x 8	8' - 16'	~192	#3	PPLP/ESLP	Yes
1 x 10	16'	~160	#3	PPLP/ESLP	Yes
1 x 12	8' - 16'	~128	#3	PPLP/ESLP	Yes

Features & Benefits:

- All #3 boards are Ponderosa Pine Lodgepole Pine mix and KDHT stamped
- Excellent for concrete forming, industrial packaging and crating, and roofing
- Sold in full units only

INDUSTRIAL BOARDS



Available Sizes:

Item	SKU	Lengths	Unit Size	Grade	HT Stamp
1x4	1414	16'	588 Pcs	Industrial	Yes

Features & Benefits:

- A mill downfall grade that contains a good mix of #3 and even #2 grade boards
- 1x4 is an excellent solution for crating, roof purlins, and concrete forming
- Excellent price and value compared to #3 boards
- All boards are KDHT stamped

WP4/116 CARSIDING



Available Sizes:

Item	Lengths	Unit Size	Exposure	Coverage	Grade	Pattern
1x6 Carsiding	8' - 16'	180	5"	240 LF/SQ	#2 Premier	WP4/116
1x8 Carsiding	8' - 16'	140	6.75"	180 LF/SQ	#2 Premier	WP4/116

PINE BEADED CEILING

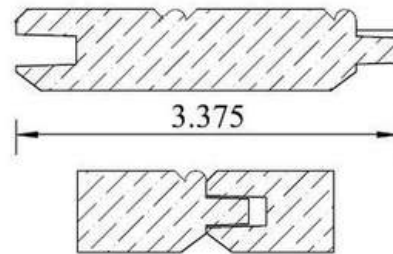

Available Sizes:

Item	Lengths	Unit Size	Exposure	Coverage	Grade	Pattern
1x4 Beaded	12' & 16'	280	3"	400 LF/SQ	#2 Premier	E&CB/WP4

NICKEL GAP SHIPLAP



1x6 Shiplap

5" Exposure

240 LF per 100 square feet

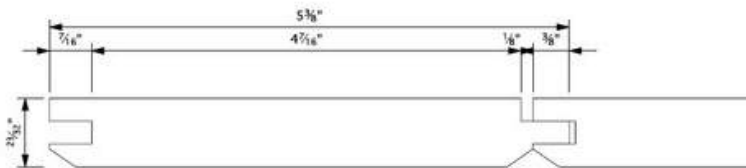

1x8 Shiplap

6 3/4" Exposure

180 LF per 100 square feet

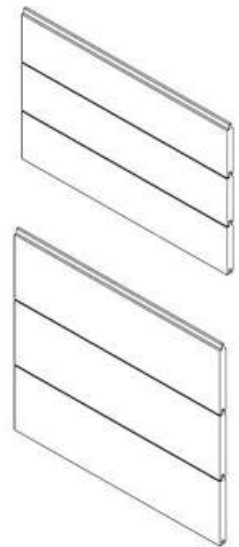
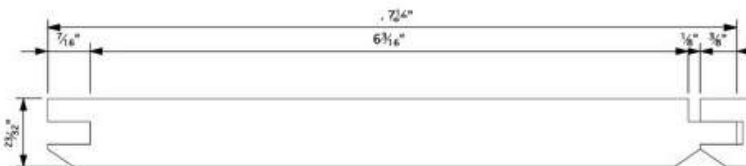

BOARDS

Available Sizes:

Item	Lengths	Unit Size	Exposure	Coverage	Grade	Finish
1 x 6 Primed Nickel Gap	16'	133	5"	240 LF/SQ	Clear FJ Radiata	Double Primed
1 x 8 Primed Nickel Gap	16'	114	6-3/4"	180 LF/SQ	Clear FJ Radiata	Double Primed
1 x 6 Raw Pine Nickel Gap	8' - 16'	180	5"	240 LF/SQ	#2 Premier Pine	Raw Pine
1 x 8 Raw Pine Nickel Gap	8' - 16'	140	6-3/4"	180 LF/SQ	#2 Premier Pine	Raw Pine

Features & Benefits:

- Raw Pine product is a #2 White Pine; can be stained, whitewashed, or painted
- Clear primed product is a double primed finger jointed Radiata Pine

WOODTONE PRE-FINISHED WALL & CEILING



V-GROOVE
A classic v-joint tongue and groove wood paneling profile.



SHIPLAP
A modern, end-matched, square edge, knotty profile.



Available Sizes:

Item	SKU	Actual Size	Lengths	Coverage	Species
1x6 V-Groove Pre-Finished	WT1616V__	3/4" x 5-1/2"	16'	240 LF/SQ	#2 Prem ESLP
1x8 Shiplap Pre-Finished	WT1816SL__	3/4" x 7-1/4"	16'	185 LF/SQ	#2 Prem ESLP



AMERICAN NUT BROWN



ENGLISH PORTER

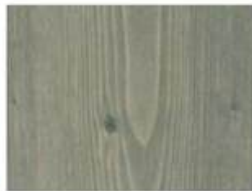

SMOKEY BOURBON



TEXAS HONEY BROWN



IRISH CREAM

Features & Benefits:

- Pre-stained material making for a streamlined and efficient install
- Premium #2 ESLP knotty substrate
- End-matched and all 16' lengths
- Intended for interior or protected exterior applications

PRIMED CENTURION FINGER JOINTED RADIATA PINE



Available Sizes:

Item	SKU	Lengths	Unit Size	Species	Finish
1 x 4 Centurion S4S	1416CFJ	16'	252	FJ Radiata Pine	Double Primed
1 x 6 Centurion S4S	1616CFJ	16'	147	FJ Radiata Pine	Double Primed
1 x 8 Centurion S4S	1816CFJ	16'	105	FJ Radiata Pine	Double Primed
1 x 12 Centurion S4S	11216CFJ	16'	84	FJ Radiata Pine	Double Primed
1 x 6 Centurion Beaded/V-Groove	1616CFJECB	16'	147	FJ Radiata Pine	Double Primed
1 x 8 Centurion Beaded/V-Groove	1816CFJECB	16'	105	FJ Radiata Pine	Double Primed
1 x 6 Centurion Nickel Gap T&G	1616CNG	16'	147	FJ Radiata Pine	Double Primed
1 x 8 Centurion Nickel Gap T&G	1816CNG	16'	105	FJ Radiata Pine	Double Primed

1x6 Nickel Gap

- 5" Exposure, 240 LF/Sq.
- Available in lengths 8'-16'

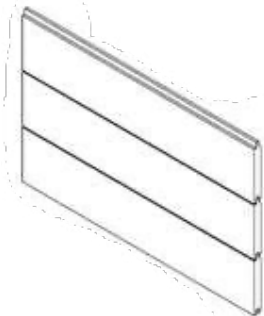
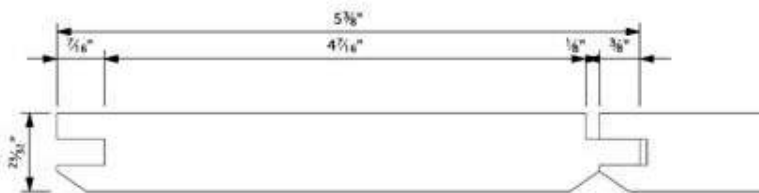

1x8 Nickel Gap

- 6-3/4" Exposure, 180 LF/Sq.
- Available in lengths 8'-16'

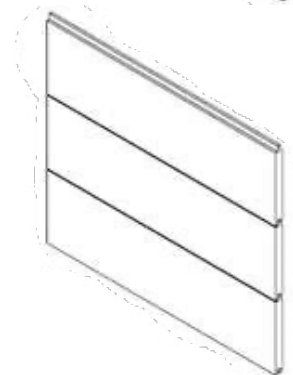
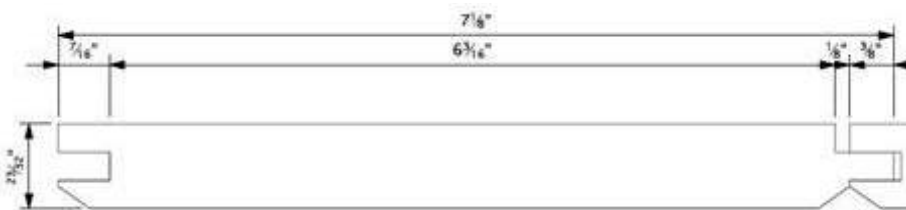

Features & Benefits:

- Manufactured from New Zealand Radiata Pine to the highest precision standard
- Approved for exterior use and is backed by a 50-year warranty against fungal decay, rot, and insects.
- Pre-coated with a 100% acrylic primer and UV sealant undercoat
- One of the highest quality finishes for a pristine installed look
- Installs just like wood and can be cut, fastened and installed with regular woodworking tools

BOARDS

WHITE MELAMINE SHELVING



Available Sizes:

Item	Thickness	Unit Size
11.25" x 12' Melamine Shelving	3/4"	48
15.25" x 12' Melamine Shelving	3/4"	36
23.25" x 12' Melamine Shelving	3/4"	34

Thermally Fused Laminate, Particleboard Core, Good 2 side, square edge band.

Applications:

- Commercial shelving
- Display systems
- Cabinets
- Furniture
- Shelving brackets

CLEAR S4S SOLID POPLAR



Available Sizes:

Item	SKU	Actual Size	Lengths	Unit Size	Species	Grade
<i>1 x 4 Poplar</i>	<i>14PCB</i>	<i>0.75" x 3.5"</i>	<i>8' - 16' R/L</i>	<i>250 BF</i>	<i>Poplar</i>	<i>Clear S4S Solid</i>
<i>1 x 6 Poplar</i>	<i>16PCB</i>	<i>0.75" x 5.5"</i>	<i>8' - 16' R/L</i>	<i>250 BF</i>	<i>Poplar</i>	<i>Clear S4S Solid</i>
<i>1 x 8 Poplar</i>	<i>18PCB</i>	<i>0.75" x 7.25"</i>	<i>8' - 16' R/L</i>	<i>250 BF</i>	<i>Poplar</i>	<i>Clear S4S Solid</i>
<i>1 x 12 Poplar</i>	<i>112PCB</i>	<i>0.75" x 11.25"</i>	<i>8' - 16' R/L</i>	<i>250 BF</i>	<i>Poplar</i>	<i>Clear S4S Solid</i>
<i>5/4 x 6 Poplar</i>	<i>546PCB</i>	<i>1" x 5.5"</i>	<i>8' - 16' R/L</i>	<i>250 BF</i>	<i>Poplar</i>	<i>Clear S4S Solid</i>
<i>5/4 x 8 Poplar</i>	<i>548PCB</i>	<i>1" x 7.25"</i>	<i>8' - 16' R/L</i>	<i>250 BF</i>	<i>Poplar</i>	<i>Clear S4S Solid</i>
<i>1 x 4 Pulled to Length</i>	<i>14_PCB</i>	<i>0.75" x 3.5"</i>	<i>8', 10', 12'</i>	<i>-</i>	<i>Poplar</i>	<i>Clear S4S Solid</i>
<i>1 x 6 Pulled to Length</i>	<i>16_PCB</i>	<i>0.75" x 5.5"</i>	<i>8', 10', 12'</i>	<i>-</i>	<i>Poplar</i>	<i>Clear S4S Solid</i>
<i>1 x 8 Pulled to Length</i>	<i>18_PCB</i>	<i>0.75" x 7.25"</i>	<i>8', 10', 12'</i>	<i>-</i>	<i>Poplar</i>	<i>Clear S4S Solid</i>

Features & Benefits:

- C&tr S4S - will be a clear board with the rare pencil sized knot
- Light, soft, and carpenter friendly wood that will easily cut and nail
- High level of dimensional stability
- Excellent for painting or staining
- Great for trim work, stairs, cabinets, shelving, and more

C&BTR S4S RADIATA PINE



Available Sizes:

Item	Actual Size	Lengths	Grade	Species
<i>1 x 4 Clear Pine</i>	<i>0.75" x 3.5"</i>	<i>Varies</i>	<i>C&Btr</i>	<i>Radiata Pine</i>
<i>1 x 6 Clear Pine</i>	<i>0.75" x 5.5"</i>	<i>Varies</i>	<i>C&Btr</i>	<i>Radiata Pine</i>
<i>1 x 8 Clear Pine</i>	<i>0.75" x 7.25"</i>	<i>Varies</i>	<i>C&Btr</i>	<i>Radiata Pine</i>
<i>1 x 12 Clear Pine</i>	<i>0.75" x 11.25"</i>	<i>Varies</i>	<i>C&Btr</i>	<i>Radiata Pine</i>

Features & Benefits:

- Imported from New Zealand and cut from some of the finest Radiata Pine in the world
- Clear stain or paint grade
- Available in prime 12' and 16' lengths

WESTERN RED CEDAR



Cedar is in our DNA, and we focus only on sourcing high-quality material from the best manufacturers in the world.

Factors we look for are:

Fiber Quality – We stock premium coastal Western Red Cedar

Color – The darker and richer, the better

Texture & Grain – We want to showcase the natural beauty of Cedar

Assortment – We have the deepest inventory of on-ground Cedar

OUR PROUD PARTNER:



Western Forest Products Inc.

DEFINING A HIGHER STANDARD™

CEDAR DECKING



Interfor Regal AK Architect Knotty Decking



Available Sizes:

Item	Actual Size	Lengths	Species	Grade	Finish
<i>2 x 4 KD Regal</i>	<i>1-9/16" x 3-9/16"</i>	<i>8' - 16'</i>	<i>Western Red Cedar</i>	<i>Architectural Knotty</i>	<i>Kiln Dried</i>
<i>2 x 6 KD Regal</i>	<i>1-9/16" x 3-9/16"</i>	<i>8' - 20'</i>	<i>Western Red Cedar</i>	<i>Architectural Knotty</i>	<i>Kiln Dried</i>

Features & Benefits:

- Coastal Western Red Cedar milled in British Columbia
- The premier Architectural Knotty decking in the Midwest
- Kiln Dried decking: more dimensionally stable, easier to stain, and lighter
- Beautiful rich auburn color with tight uniform grain
- Contains natural oils and resins that make it resistant to rot, decay, and insects
- All knots are sound and tight, maximum knot size = 2 7/8" and wane is strictly limited to the reverse face only

5/4 X 6 WESTERN RED CEDAR DECKING



Available Sizes:

Item	Actual Size	Lengths	Species Grade
5/4 x 6 Cedar	1-1/32" x 5-1/2"	8' - 20'	Western Red Cedar Architectural Knotty

Features & Benefits:

- Roughly 25% less than 2x6 Cedar decking
- Contains natural oils and resins that make it resistant to rot, decay, and insects
- All knots are sound and tight
- Maximum knot size = 2 3/4

CEDAR BOARDS



Available Sizes:

Item	Actual Size	Lengths	Finish	Grade
1x4	3/4" x 3-9/16"	8' - 20'	Smooth/Rough	Appearance
1x6	3/4" x 5-9/16"	8' - 20'	Smooth/Rough	Appearance
1x8	3/4" x 7-3/8"	8' - 20'	Smooth/Rough	Appearance
1x10	3/4" x 9-3/8"	8' - 20'	Smooth/Rough	Appearance
1x12	3/4" x 11-3/8"	8' - 20'	Smooth/Rough	Appearance

Features & Benefits:

- True Western Red Cedar milled in British Columbia
- Appearance Grade no-hole knotty boards; straight, uniform grain and even texture
- "No Prior Select" meaning that grades are *not pulled out* during production
- S1S2E (smooth one side, two edges)

CEDAR TIMBERS



Available Sizes:

Item	Actual Size	Lengths	Grade	KD/Green
4 x 4 Rough	3-11/16" x 3-11/16"	8' - 16'	Appearance	Green
4 x 6 Rough	4" x 6"	8' - 20'	Appearance	Green
4 x 8 Rough	4" x 8"	8' - 20'	Appearance	Green
4 x 10 Rough	4" x 10"	8' - 20'	Appearance	Green
4 x 12 Rough	4" x 12"	8' - 20'	Appearance	Green
6 x 6 Rough	6" x 6"	8' - 20'	Appearance	Green
6 x 8 Rough	6" x 8"	8' - 20'	Appearance	Green
6 x 12 Rough	6" x 12"	8' - 24'	Appearance	Green
8 x 8 Rough	8" x 8"	8' - 20'	Appearance	Green
8 x 12 Rough	8" x 12"	8' - 20'	Appearance	Green
10 x 10 Rough	10" x 10"	8' - 24'	Appearance	Green
12 x 12 Rough	12" x 12"	8' - 24'	Appearance	Green

4 x 4 Smooth	3-11/16" x 3-11/16"	8' - 16'	Appearance	Green
6 x 6 Smooth	5-1/2" x 5-1/2"	8' - 20'	Appearance	Green

Features & Benefits:

- Premium coastal Western Red Cedar milled in British Columbia
- Appearance grade no hole knotty cedar with four square edges
- Great for both interior appearance applications, and exterior structural posts/beams

CEDAR DIMENSIONAL



Available Sizes:

Item	Actual Size	Length	KD/Green	Grade
<i>2x2 Smooth</i>	<i>1-9/16" x 1-9/16"</i>	<i>3', 4', 8'</i>	<i>Green</i>	<i>Appearance Grade</i>
<i>2x4 Smooth</i>	<i>1-9/16" x 3-9/16"</i>	<i>8' - 20'</i>	<i>Green</i>	<i>Appearance Grade</i>
<i>2x6 Smooth</i>	<i>1-9/16" x 5-9/16"</i>	<i>8' - 20'</i>	<i>Green</i>	<i>Appearance Grade</i>
<i>2x8 Smooth</i>	<i>1-9/16" x 7-3/8"</i>	<i>8' - 20'</i>	<i>Green</i>	<i>Appearance Grade</i>
<i>2x10 Smooth</i>	<i>1-9/16" x 9-3/8"</i>	<i>8' - 20'</i>	<i>Green</i>	<i>Appearance Grade</i>
<i>2x12 Smooth</i>	<i>1-9/16" x 11-3/8"</i>	<i>8' - 20'</i>	<i>Green</i>	<i>Appearance Grade</i>
<i>2x4 Rough</i>	<i>1-3/4" x 3-3/4"</i>	<i>8' - 20'</i>	<i>Green</i>	<i>Appearance Grade</i>
<i>2x6 Rough</i>	<i>1-3/4" x 5-3/4"</i>	<i>8' - 20'</i>	<i>Green</i>	<i>Appearance Grade</i>
<i>2x8 Rough</i>	<i>1-3/4" x 7-3/4"</i>	<i>8' - 20'</i>	<i>Green</i>	<i>Appearance Grade</i>
<i>2x10 Rough</i>	<i>1-3/4" x 9-3/4"</i>	<i>8' - 20'</i>	<i>Green</i>	<i>Appearance Grade</i>
<i>2x12 Rough</i>	<i>1-3/4" x 11-3/4"</i>	<i>8' - 20'</i>	<i>Green</i>	<i>Appearance Grade</i>

Features & Benefits:

- Premium coastal Western Red Cedar milled in British Columbia
- All Cedar is a no-hole knotty appearance grade with extremely limited wane
- Rough cedar is a full rough cut and run through a rougher header to achieve a high-quality appearance

WOODTONE CEDAR STRUCTURAL POSTS

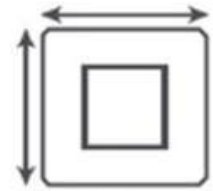

8x8

Actual: 7 1/4" x 7 1/4"

Inside: 4 1/4" x 4 1/4"

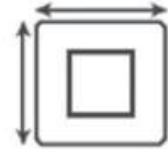

6x6

Actual: 5 1/2" x 5 1/2"

Inside: 2 5/8" x 2 5/8"

Available Sizes:

Item	Actual Dimension	Lengths	Unit Size	Species	Texture	Finish
6 x 6 Primed SPF	5-1/2" x 5-1/2"	10' & 12'	45	SPF	Resawn	Primed
8 x 8 Primed SPF	7-1/4" x 7-1/4"	10' & 12'	28	SPF	Resawn	Primed
6 x 6 Cedar	5-1/2" x 5-1/2"	10' & 12'	45	Cedar	Resawn	Raw Cedar
8 x 8 Cedar	7-1/4" x 7-1/4"	10' & 12'	28	Cedar	Resawn	Raw Cedar
6 x 6 Cedar S4S	5-1/2" x 5-1/2"	10' & 12'	45	Cedar	Smooth	Raw Cedar
8 x 8 Cedar S4S	7-1/4" x 7-1/4"	10' & 12'	28	Cedar	Smooth	Raw Cedar

Features & Benefits:

- Engineered to eliminate heavy checking, splits, warp, twist, and bow
- Lightweight and easy to position
- Hollow core allows for electrical to be run through the post
- Available in a primed and paint ready SPF, and a raw Western Red Cedar
- Fully structural with load tables that can be designed into structural support posts

CEDAR SPLIT RAIL FENCING



Available Sizes:

Item	Length	Girth	Species	Unit Size
<i>10' Split Rail</i>	<i>10'</i>	<i>12" - 14"</i>	<i>Red Cedar</i>	<i>155</i>
<i>2-Hole Line Post</i>	<i>64"</i>	<i>18" +</i>	<i>Red Cedar</i>	<i>72</i>
<i>2-Hole Corner Post</i>	<i>64"</i>	<i>18" +</i>	<i>Red Cedar</i>	<i>72</i>
<i>2-Hole End Post</i>	<i>64"</i>	<i>18" +</i>	<i>Red Cedar</i>	<i>72</i>
<i>3-Hole Line Post</i>	<i>78"</i>	<i>18" +</i>	<i>Red Cedar</i>	<i>72</i>
<i>3-Hole Corner Post</i>	<i>78"</i>	<i>18" +</i>	<i>Red Cedar</i>	<i>72</i>
<i>3-Hole End Post</i>	<i>78"</i>	<i>18" +</i>	<i>Red Cedar</i>	<i>72</i>

Features & Benefits:

- Durability and Low Maintenance: Cedar is a naturally rot-resistant wood, meaning your fence will last for many years.
- Natural Beauty: Cedar has a warm, rustic look that complements a variety of landscapes. It weathers naturally to a silver-gray color, adding to its charm.
- Cost-Effective: Cedar split rail fencing is typically more affordable than other types of fences, due to the use of less material and a simpler installation process.
- Scalability: Split rail fences can easily span longer distances between posts, making them ideal for large properties and creating a sense of openness.

CEDAR DOG EAR FENCING



Available Sizes:

Item	SKU	Actual Size	Finish	Unit Size	Species
<i>3/4" x 6' Dog Ear</i>	<i>166CF</i>	<i>3/4" x 5-1/2" x 6'</i>	<i>Smooth/Rough</i>	<i>256</i>	<i>Western Red</i>
<i>5/8" x 6' Dog Ear</i>	<i>5866CDJ</i>	<i>5/8" x 5-1/2" x 6'</i>	<i>Rough/Rough</i>	<i>528</i>	<i>Japanese Sugi</i>

Features & Benefits:

- Contains natural oils and resins that make it resistant to rot and decay
- 6' Tall and Dog Eared Trimmed
- 5.5" Wide
- Full 3/4" thick fencing is extremely durable and stout
- Excellent for backyards with kids and kicked soccer balls and toys

MODERN HORIZONTAL CEDAR FENCING



Available Sizes:

Item	Size	Species	Qty per 8' Section
<i>Line Post</i>	<i>4x4x8</i>	<i>Western Red Cedar</i>	<i>1 piece</i>
<i>Middle Support Post</i>	<i>2x4x8</i>	<i>Western Red Cedar</i>	<i>1 piece</i>
<i>Horizontal Boards</i>	<i>1x6x8</i>	<i>Western Red Cedar</i>	<i>13 pieces</i>
<i>Top Cap (optional)</i>	<i>1x6x8</i>	<i>Western Red Cedar</i>	<i>1 piece</i>
<i>Fascia (optional)</i>	<i>1x4x8</i>	<i>Western Red Cedar</i>	<i>1 piece</i>

Features & Benefits:

- Creates a modern and sophisticated look, perfect for restaurants and patios
- Long lasting, easy to maintain, and fast installation

PRIMED CEDAR BEVEL SIDING



Available Sizes:

Item	Actual Size	Lengths	Exposure	Coverage	Finish	Grade
<i>1/2" x 6" Primed Cedar Bevel</i>	<i>1/2" x 5-3/8"</i>	<i>16'</i>	<i>4"</i>	<i>300 LF/SQ</i>	<i>Woodgrain/Smooth</i>	<i>Clear VG</i>
<i>3/4" x 8" Primed Cedar Bevel</i>	<i>11/16" x 7-1/4"</i>	<i>16'</i>	<i>6"</i>	<i>200 LF/SQ</i>	<i>Woodgrain/Smooth</i>	<i>Select Knotty</i>
<i>3/4" x 10" Primed Cedar Bevel</i>	<i>11/16" x 9-1/4"</i>	<i>16'</i>	<i>8"</i>	<i>150 LF/SQ</i>	<i>Woodgrain/Smooth</i>	<i>Select Knotty</i>

Features & Benefits:

- Cedar bevel siding in prime 16' lengths
- Pre-primed and ready to paint
- Fully reversible, rough sawn face, smooth backside
- Lightweight and easy to install

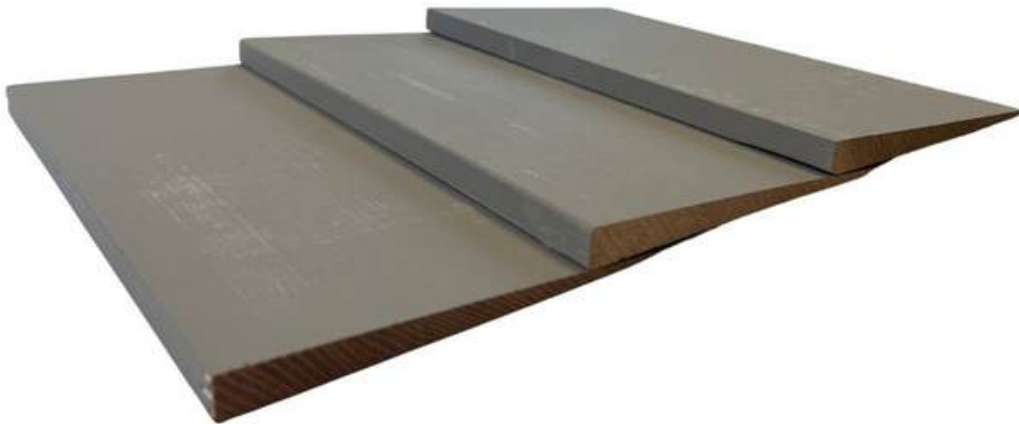

CEDAR BEVEL SIDING

Clear



Knotty



Available Sizes:

Item	Exposure	Coverage	Lengths	Kiln Dried	Grade
<i>1/2" x 6" Clear</i>	<i>4"</i>	<i>300 LF/SQ</i>	<i>3' - 20' R/L</i>	<i>Yes</i>	<i>Clear</i>
<i>1/2" x 8" Clear</i>	<i>6"</i>	<i>200 LF/SQ</i>	<i>3' - 20' R/L</i>	<i>Yes</i>	<i>Clear</i>
<i>3/4" x 8" Knotty</i>	<i>6"</i>	<i>200 LF/SQ</i>	<i>8' - 20'</i>	<i>Yes</i>	<i>Arch. Knotty</i>
<i>3/4" x 10" Knotty</i>	<i>8"</i>	<i>150 LF/SQ</i>	<i>8' - 20'</i>	<i>Yes</i>	<i>Arch. Knotty</i>

Features & Benefits:

- Premium coastal Western Red Cedar siding milled in British Columbia
- Contains natural oils and resins that make it resistant to rot, decay, and insects
- Kiln dried, lightweight, and easy to work with

CEDAR V-JOINT SIDING



Available Sizes:

Item	Actual Size	Finish	Coverage	Lengths	KD/Green	Grade
<i>1x6 V-Joint</i>	11/16" x 5-3/8"	<i>Smooth/Rough</i>	<i>240 LF/SQ</i>	<i>8' - 20'</i>	<i>KD</i>	<i>Architect Knotty</i>
<i>1x8 V-Joint</i>	11/16" x 7-3/8"	<i>Smooth/Rough</i>	<i>180 LF/SQ</i>	<i>8' - 20'</i>	<i>KD</i>	<i>Architect Knotty</i>

CEDAR CHANNEL SIDING



Available Sizes:

Item	Exposure	Finish	Coverage	Lengths	KD/Green	Grade
<i>1x8 Channel</i>	<i>6-1/4"</i>	<i>Rough</i>	<i>195 LF/SQ</i>	<i>8' - 20'</i>	<i>KD</i>	<i>Architect Knotty</i>
<i>1x10 Channel</i>	<i>8-1/4"</i>	<i>Rough</i>	<i>145 LF/SQ</i>	<i>8' - 20'</i>	<i>KD</i>	<i>Architect Knotty</i>

CEDAR NICKEL GAP

Rough Face



Smooth Face

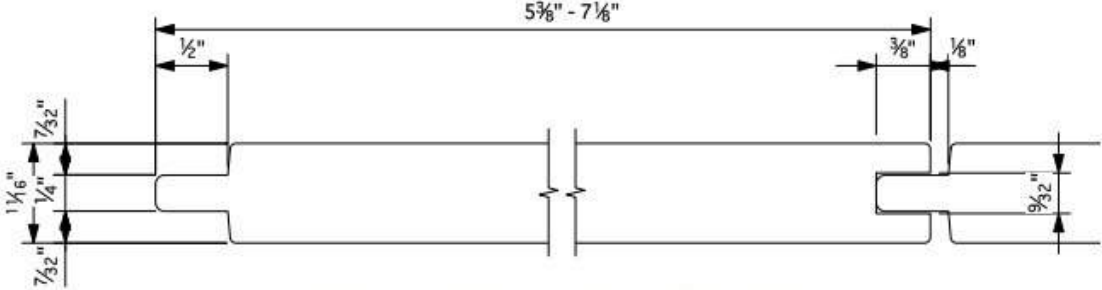

Elite Finline (1/8th Gap) Paneling

Available Sizes:

Item	Lengths	Exposure	Coverage	Finish	Species
1x6 Finline	8' - 16'	5"	240 LF/SQ	Smooth/Rough	Western Red Cedar
1x8 Finline	8' - 16'	6-3/4"	180 LF/SQ	Smooth/Rough	Western Red Cedar

Features & Benefits:

- Modern tongue & groove profile with a built-in 1/8" nickel gap
- Premium coastal Western Red Cedar
- Reversible product with a rough sawn face and smooth back

WAVY EDGE CEDAR SIDING



Available Sizes:

Item	Actual Dimension	Lengths	Exposure	Coverage
<i>1x10 Wavy Edge</i>	<i>15/16" x 10"</i>	<i>8' - 16'</i>	<i>7.5"</i>	<i>160 LF/SQ</i>

Features & Benefits:

- Coastal Western Red Cedar milled in British Columbia
- Tight-knot appearance grade
- Natural and variable wavy edge for an authentic rustic look

SHAKERTOWN CEDAR PANEL SIDING

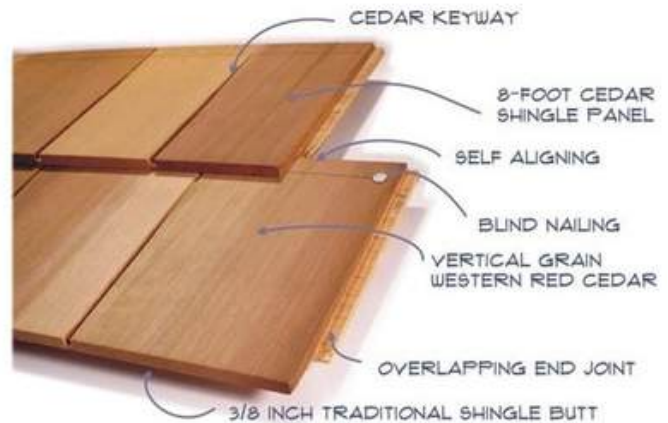

Available Sizes:

Item	Size	Coverage	Finish
<i>7" Even Butt Keyway Style</i>	<i>7" Face x 8' Panel</i>	<i>22 Pcs/Square</i>	<i>Raw Cedar</i>

Features & Benefits:

- Strikingly beautiful and professional look
- Pre-assembled panel with the highest quality Cedar Shingle
- Even butt and keyway style for clean modern age look
- Self aligning, blind nailing line, and overlapping end joint for fast and easy installation
- Can be special ordered with a factory finish stain

CEDAR SHAKES



Available Sizes:

Item	Length	Thickness	Exposure	Grade	Coverage
<i>Medium Shakes</i>	24"	1/2" - 3/4"	10"	#1 Grade	20 Sq Ft/Bundle
<i>Heavy Shakes</i>	24"	3/4" - 5/4"	10"	#1 Grade	20 Sq Ft/Bundle
<i>Heavy Class C Fire Treated</i>	24"	3/4" - 5/4"	10"	#1 Grade	20 Sq Ft/Bundle
<i>Heavy CCA Treated</i>	24"	3/4" - 5/4"	10"	#1 Grade	20 Sq Ft/Bundle

Features & Benefits:

- Shakes are hand-split to leave a less uniform more natural and rustic look
- Cedar Shake & Shingle Bureau Certified #1 Blue Label Quality – the absolute best
- Available in raw Cedar, Class C Fire Treated, or CCA Treated
- 24" long with a 10" exposure – varying widths 4" – 14" wide

CEDAR SHINGLES



Available Sizes:

Item	Lengths	Grade	Roof		Wall	
			Exposure	Coverage	Exposure	Coverage
16" Fivex	16"	#1 Blue Label 100% Edge Grain	5"	25 Sq Ft	7"	33 Sq Ft
18" Perfections	18"	#1 Blue Label 100% Edge Grain	5.5"	25 Sq Ft	7.5"	33 Sq Ft
24" Royals	24"	#1 Blue Label 100% Edge Grain	7.5"	25 Sq Ft	10.5"	33 Sq Ft

Features & Benefits:

- Shingles are uniformly sawn for a consistent and even thickness and provide a uniform machine-like look
- Cedar Shake & Shingle Bureau Certified #1 Blue Label Quality – the absolute best
- Can be used for both roofing and sidewalls
- Varying widths ranging from 3" – 14" wide; average width is 6" – 8" wide

CEDAR SHAKE & SHINGLE ACCESSORIES

Hip & Ridge



#4 Undercourse



Available Sizes:

Item	Lengths	Grade	Coverage
<i>Hip & Ridge</i>	24"	#1	16.6 LF
<i>#3/#4 Undercourse</i>	18"	#3/#4	50 LF

CEDAR

CEDAR BREATHER



Item	SKU	Thickness	Actual Size	Coverage
<i>Cedar Breather</i>	CB200	.27" (Without Compression)	.27" x 39" x 61.5'	200 Sq Ft

DOUGLAS FIR TIMBERS



Available Sizes:

Item	Actual Size	Species	Grade	Lengths	Surface	Green/KD
4 x 4	4" x 4"	Douglas Fir	#1 FOHC	8' - 24' *	Rough Sawn & S4S	Green
4 x 6	4" x 6"	Douglas Fir	#1 FOHC	8' - 24' *	Rough Sawn & S4S	Green
4 x 8	4" x 8"	Douglas Fir	#1 FOHC	8' - 24' *	Rough Sawn & S4S	Green
4 x 10	4" x 10"	Douglas Fir	#1 FOHC	8' - 24' *	Rough Sawn & S4S	Green
4 x 12	4" x 12"	Douglas Fir	#1 FOHC	8' - 24' *	Rough Sawn & S4S	Green
6 x 6	6" x 6"	Douglas Fir	#1 FOHC	8' - 24' *	Rough Sawn & S4S	Green
6 x 8	6" x 8"	Douglas Fir	#1 FOHC	8' - 24' *	Rough Sawn & S4S	Green
6 x 10	6" x 10"	Douglas Fir	#1 FOHC	8' - 24' *	Rough Sawn & S4S	Green
6 x 12	6" x 12"	Douglas Fir	#1 FOHC	8' - 24' *	Rough Sawn & S4S	Green
6 x 16	6" x 16"	Douglas Fir	#1 FOHC	8' - 24' *	Rough Sawn & S4S	Green
8 x 8	8" x 8"	Douglas Fir	#1 FOHC	8' - 24' *	Rough Sawn & S4S	Green
8 x 12	8" x 12"	Douglas Fir	#1 FOHC	8' - 24' *	Rough Sawn & S4S	Green
8 x 16	8" x 16"	Douglas Fir	#1 FOHC	8' - 24' *	Rough Sawn & S4S	Green
10 x 10	10" x 10"	Douglas Fir	#1 FOHC	8' - 24' *	Rough Sawn & S4S	Green
12 x 12	12" x 12"	Douglas Fir	#1 FOHC	8' - 24' *	Rough Sawn & S4S	Green

Features & Benefits:

- Premium appearance grade timber that is 100% Free of Heart Center and Free of Wane
- Beautiful auburn coloring and even grain
- #1 Grade for predictable strength bearing and spans
- More affordable than comparable Western Red Cedar sizes
- Available in custom sizes and in an S4S finish

DOUGLAS FIR APPEARANCE GRADE BOARDS & DIMENSION



Available Sizes:

Item	Actual Size	Lengths	Finish	Kiln Dried
1 x 4 Doug Fir Appearance	7/8" x 3-1/2"	16'	Rough Face (S1S2E)	Yes
1 x 6 Doug Fir Appearance	7/8" x 5-1/2"	16'	Rough Face (S1S2E)	Yes
1 x 8 Doug Fir Appearance	7/8" x 7-1/4"	16'	Rough Face (S1S2E)	Yes
1 x 12 Doug Fir Appearance	7/8" x 11-1/4"	12' - 18'	Rough Face (S1S2E)	Yes
2 x 6 Doug Fir Appearance	1-3/4" x 5-5/8"	16'	Full Rough	Yes
2 x 8 Doug Fir Appearance	1-3/4" x 7-1/2"	16'	Full Rough	Yes
2 x 12 Doug Fir Appearance	1-3/4" x 11-1/2"	16'	Full Rough	Yes

**Available on-ground sizes may vary*

Features & Benefits Boards:

- Tight knot appearance grade board
- Kiln Dried (12-15% moisture content)
- Rougher-headed face (smooth backside and two edges)
- Excellent price when compared to Cedar
- Full 7/8" thick
- Beautiful color, texture, and grain

Features & Benefits Dimension:

- Tight knot appearance grade dimension
- Kiln Dried (12-15% moisture content)
- Rougher-headed finish on all four sides
- Excellent price when compared to Cedar
- Full 1.75" thick
- Beautiful color, texture, and grain

C&BTR DOUGLAS FIR



Available Sizes:

Item	Actual Size	Length	Unit Size	Species	Grade
<i>1x4</i>	<i>0.75" x 3.5"</i>	<i>R/L 8' - 20'</i>	<i>1000 BF</i>	<i>Douglas Fir</i>	<i>C&BTR</i>
<i>1x6</i>	<i>0.75" x 5.5"</i>	<i>R/L 8' - 20'</i>	<i>1000 BF</i>	<i>Douglas Fir</i>	<i>C&BTR</i>
<i>1x8</i>	<i>0.75" x 7.25"</i>	<i>R/L 8' - 20'</i>	<i>1000 BF</i>	<i>Douglas Fir</i>	<i>C&BTR</i>
<i>1x10</i>	<i>0.75" x 9.25"</i>	<i>R/L 8' - 20'</i>	<i>1000 BF</i>	<i>Douglas Fir</i>	<i>C&BTR</i>
<i>1x12</i>	<i>0.75" x 11.25"</i>	<i>R/L 8' - 20'</i>	<i>1000 BF</i>	<i>Douglas Fir</i>	<i>C&BTR</i>
<i>5/4x4</i>	<i>1" x 3.5"</i>	<i>R/L 8' - 20'</i>	<i>1000 BF</i>	<i>Douglas Fir</i>	<i>C&BTR</i>
<i>5/4x6</i>	<i>1" x 5.5"</i>	<i>R/L 8' - 20'</i>	<i>1000 BF</i>	<i>Douglas Fir</i>	<i>C&BTR</i>
<i>5/4x8</i>	<i>1" x 7.25"</i>	<i>R/L 8' - 20'</i>	<i>1000 BF</i>	<i>Douglas Fir</i>	<i>C&BTR</i>
<i>2x4</i>	<i>1.5" x 3.5"</i>	<i>R/L 8' - 20'</i>	<i>1000 BF</i>	<i>Douglas Fir</i>	<i>C&BTR</i>
<i>2x6</i>	<i>1.5" x 5.5"</i>	<i>R/L 8' - 20'</i>	<i>1000 BF</i>	<i>Douglas Fir</i>	<i>C&BTR</i>
<i>2x8</i>	<i>1.5" x 7.25"</i>	<i>R/L 8' - 20'</i>	<i>1000 BF</i>	<i>Douglas Fir</i>	<i>C&BTR</i>
<i>2x10</i>	<i>1.5" x 9.25"</i>	<i>R/L 8' - 20'</i>	<i>1000 BF</i>	<i>Douglas Fir</i>	<i>C&BTR</i>
<i>2x12</i>	<i>1.5" x 11.25"</i>	<i>R/L 8' - 20'</i>	<i>1000 BF</i>	<i>Douglas Fir</i>	<i>C&BTR</i>

Features & Benefits:

- The highest quality C&btr Douglas Fir, excellent for exterior millwork
- All material is S4S, Mixed Grain, and Kiln Dried
- Sold in full units or job pack quantities

DOUGLAS FIR T&G PATTERN STOCK



1x6 Fir V-Groove



Item	Lengths	Exposure	Coverage	Profile	Species	Grade	Finish
1 x 6 Fir Appearance Grade V-Groove	16'	5"	240 LF/SQ	V-Groove	Douglas Fir	Appearance	Smooth/Rough

Features & Benefits:

- Premium appearance grade knotty Douglas Fir
- All knots are sound and tight
- Premium 16' lengths
- Fully reversible with a smooth and rough textured face
- Contains natural oils and resins that aid in the resistance to rot and decay
- Great price, and cheaper than Cedar

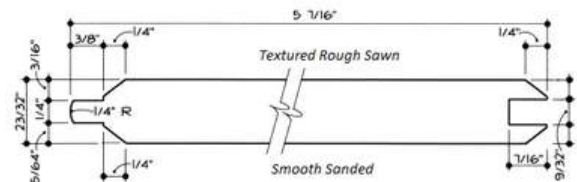

Clear Fir Nickel Gap/V-Groove

1 x 6 Clear Fir Nickel Gap/V-Groove	8' - 20' R/L	5"	240 LF/SQ	Nickel Gap/V-Groove	Douglas Fir	C&Btr	Smooth S4S
1 x 8 Clear Fir Nickel Gap/V-Groove	8' - 20' R/L	6.75"	180 LF/SQ	Nickel Gap/V-Groove	Douglas Fir	C&Btr	Smooth S4S

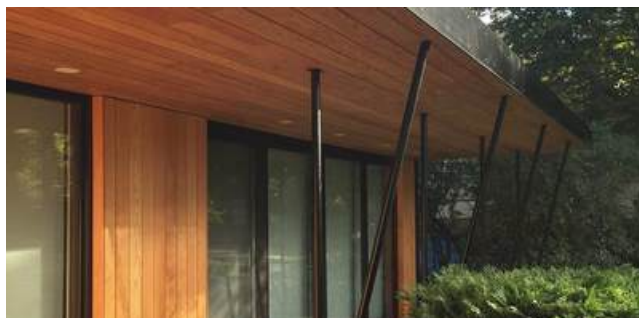

Features & Benefits:

- Cut from the finest Douglas Fir in North America
- Clear C&btr mixed grain
- Reversible with a Nickel Gap face and V-Groove backside
- Beautiful color and grain, ideal for staining or clear coats
- Contains natural oils and resins that aid in the resistance to rot and decay

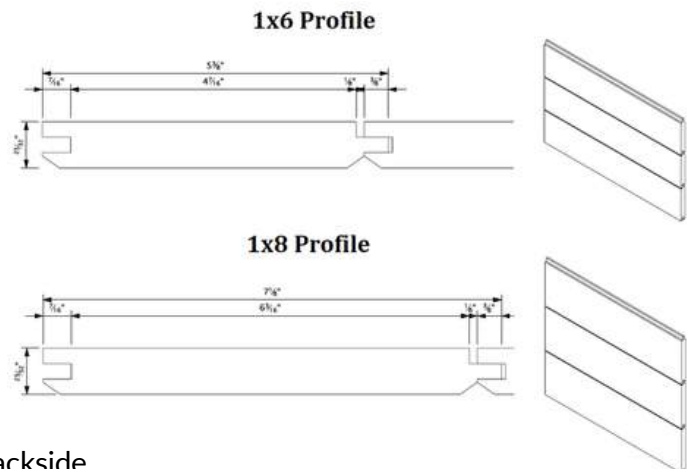

FIR PORCH FLOORING



Available Sizes:

Item	SKU	Actual Size	Lengths	Unit Size	Coverage	Grade
1 x 4 T&G Fir Flooring	14FFCBPL	23/32" x 3-1/8"	8' - 16' Evens	3000 LF	400 LF/SQ	C&Btr Mixed Grain
1 x 4 T&G VG Fir Flooring	14FFCBV	23/32" x 3-1/8"	6' - 16' Random	3000 LF	400 LF/SQ	C&Btr Vertical Grain
1 x 4 T&G Fir Flooring Pulled To Length	14_FF CBPL	23/32" x 3-1/8"	8', 10', 12'	-	400 LF/SQ	C&Btr Mixed Grain

Features & Benefits:

- 100% premium clear Douglas Fir that Historically matches traditional porch flooring
- Mixed grain and vertical grain options
- Available in a random length mix, or 8' – 12' specified lengths
- 400 lineal feet per 100 square feet of coverage

T&G ROOF DECKING

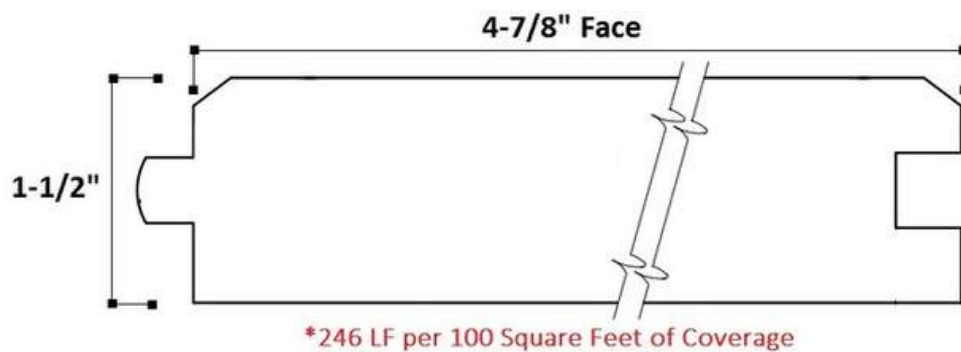

Available Sizes:

Item	Lengths	Profile	Exposure	Coverage	Species	Grade
2x6 T&G Fir	12', 14', 16', 20'	T&G WP4	4-7/8"	246 LF/SQ	Fir & Larch	Select

Features & Benefits:

- Great for roof decking, loft floors, and outdoor patios
- Face coverage = 4-7/8", so factor 246 LF per square
- Premium Select grade for appearance and strength. Beautiful color, grain, and knot structure.
- Simple span of 6'-8' is easily achievable, but always check with local designs and load factors

FIR 3X6 T&G SELECT DEX

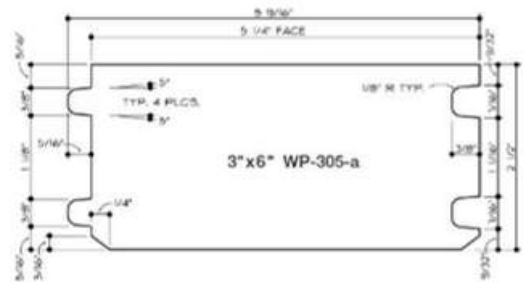

Available Sizes:

Item	Actual Size	Lengths	Coverage	Species	Grade	Unit Size
3x6 Select Dex	2-1/2" x 5-1/4"	8' - 20'	230 LF/Square	Douglas Fir	KD Select Dex	104

Features & Benefits:

- Premium Select Dex grade (similar to Select Struc)
- V-Groove exposed face
- Kiln Dried and cut from slow growth timber for added dimensional stability
- Double T&G connection
- 5-1/4" exposed face
- Simple spans of 12'-14' are easily achievable, but always check with local designs and load factors

FIR BEADED CEILING



Available Sizes:

Item	SKU	Actual Size	Lengths	Unit Size	Coverage	Grade
1 x 4 Fir Beaded R/L	14FCCB	5/8" x 3-1/8"	6' - 20' R/L	3700 LF	400 LF/SQ	C&btr Mixed Grain
1 x 4 Fir Beaded Specified	14_FCCB	5/8" x 3-1/8"	8', 12'	-	400 LF/SQ	C&btr Mixed Grain

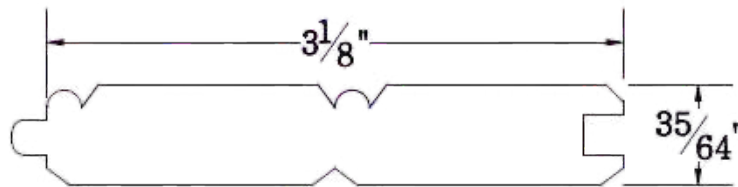

Features & Benefits:

- 100% premium clear Douglas Fir
- Mixed grain C&btr stain grade
- Available in a random length mix, or 8' or 12' specified lengths
- 400 lineal feet per 100 square feet of coverage



LOG CABIN SIDING



Available Size & Profile:

Item	SKU	Lengths	Exposure	Coverage	Species
2x8 Smooth Round Log Cabin	28_FLCS	12' & 16'	6-5/8"	180 LF/Square	Fir & Larch

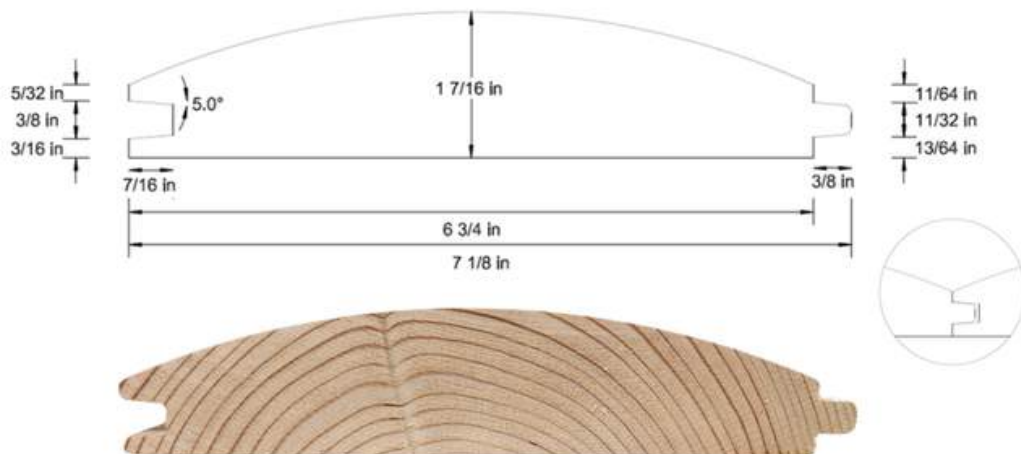

Features & Benefits:

- Douglas Fir & Larch species that has natural oils, tannins, and resins that make it resistant to rot and decay
- Beautiful color and appearance. Easy to match with other Fir products like trim, timbers, and roof decking for a uniform look
- Features a slick 5 degree bevel on the tongue and groove that creates a easy install where the tongue smoothly fits into the groove without excessive force or hammering.
- Available in prime 12' and 16' lengths

DECKORATORS DECKING

We offer four lines of Deckorators Decking, each offering unique benefits for your clients. Deckorators products are as strong and highly functional as they are attractive. Each is smartly engineered, made of top-quality materials, and durably coated for greater protection against the elements, assuring year after year of lasting beauty with minimal care.

VENTURE LINE - \$

- A low cost, value oriented wood-plastic composite deck line.
- Scalloped back, available in two colors, and sold at an amazing price.
- Venture is a great product for those looking for the lowest cost option to replace wood while still keeping minimal maintenance.

Available Colors:

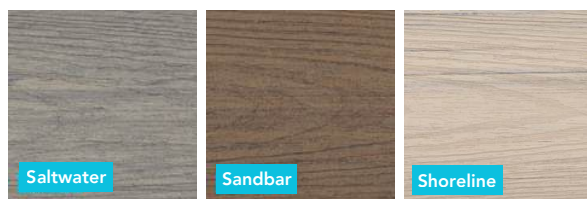

Available Profiles:

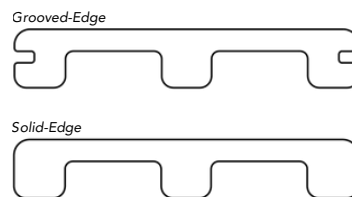

VISTA LINE - \$\$

- A well-rounded and top-performing wood-plastic capped composite deck line.
- Built with enhanced traction.
- Full 7/8" board, available in four colors, and sold at an average price point.
- Vista is a great product for those looking for solid all-around performance and longevity, but want to stay within a specific budget.

Available Colors:



Available Profiles:

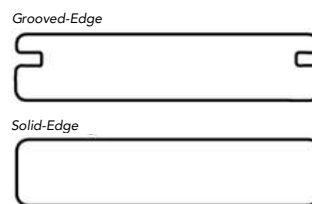

DECKORATORS DECKING

We offer four lines of Deckorators Decking, each offering unique benefits for your clients. Deckorators products are as strong and highly functional as they are attractive. Each is smartly engineered, made of top-quality materials, and durably coated for greater protection against the elements, assuring year after year of lasting beauty with minimal care.

SUMMIT LINE - \$\$

- Mineral-based composite technology, which offers the industry's best strength-to-weight ratio
- 35% lighter than other traditional composite deck boards
- Unique surface that improves traction in wet conditions
- Won't splinter, sag, chalk, or crack
- 1 1/4" fascia available in 12' length only

Available Colors:

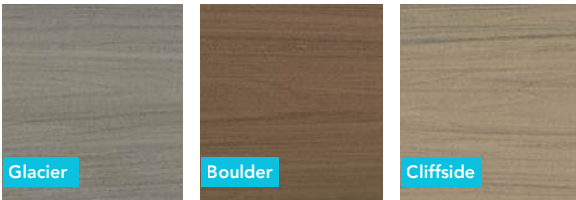



Glacier Boulder Cliffside

Available Profiles:

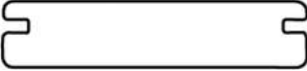
Grooved-Edge



Solid-Edge

VOYAGE LINE - \$\$\$

- A lightweight mineral-based composite with incredible durability and extremely limited movement. Built with enhanced traction.
- The best overall performing composite deck on the market.
- Full 7/8" board, available in six colors, narrow and wide boards available, and sold at a premium price level that suits the quality.
- Voyage is the right product for those looking for the best overall performance in composite decking and want their deck to look as good in year 10 as year 1.

Available Colors:





Sedona Sierra Tundra Costa Mesa Khaya

Available Profiles:

Grooved-Edge

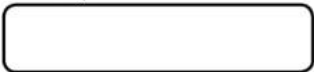

Solid-Edge

DECKORATORS DECKING - VENTURE

A wood-plastic composite deck board that offers the best combination of value and performance. Venture Decking features a natural woodgrain in three colors Saltwater (gray), Sandbar (brown), and Shoreline (tan).

Available Sizes:

Line	Type	Item	Actual Size	Unit Size
Venture	Grooved Deck Board	5/4 x 6 x 12' Grooved	15/16" x 5-1/2" x 12'	48
Venture	Grooved Deck Board	5/4 x 6 x 16' Grooved	15/16" x 5-1/2" x 16'	48
Venture	Grooved Deck Board	5/4 x 6 x 20' Grooved	15/16" x 5-1/2" x 20'	48
Venture	Solid Deck Board	5/4 x 6 x 16' Solid	15/16" x 5-1/2" x 16'	48
Venture	Solid Deck Board	5/4 x 6 x 20' Solid	15/16" x 5-1/2" x 20'	48
Venture	Fascia	1 x 12 x 12' Fascia	1/2" x 11-1/4" x 12'	40



Available Colors:

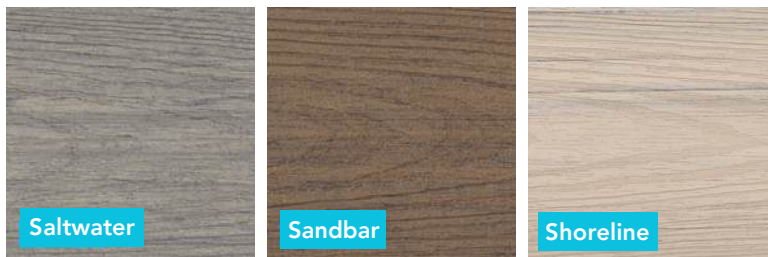

Available Profiles:

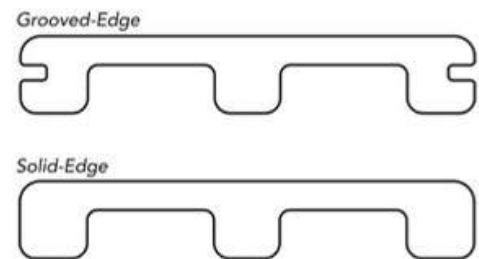

Features & Benefits:

- Scratch-resistant polyethylene cap with a strong, dense composite core
- Capped on three sides and through the groove
- Fluted backside; lightweight and easy to maneuver and position
- Easy to clean with soap and water, and resistant to rot, mold, and scratches
- Spans 16" on-center
- Backed by a 25-year limited warranty: 25-year Structural, 25-year Stain & Fade, and 25-year Limited Removal & Replacement Warranty

DECKORATORS DECKING - VISTA

A wood-plastic composite deck board with the look of exotic hardwoods without the maintenance. Deckorators Vista Line comes in four different colors Driftwood, Silverwood, Ironwood, and Dunewood.

Available Sizes:

Line	Type	Item	Actual Size	Unit Size
Vista	Grooved Deck Board	5/4 x 6 x 12' Grooved	7/8" x 5-1/2" x 12'	48
Vista	Grooved Deck Board	5/4 x 6 x 16' Grooved	7/8" x 5-1/2" x 16'	48
Vista	Grooved Deck Board	5/4 x 6 x 20' Grooved	7/8" x 5-1/2" x 20'	48
Vista	Solid Deck Board	5/4 x 6 x 16' Solid	7/8" x 5-1/2" x 16'	48
Vista	Solid Deck Board	5/4 x 6 x 20' Solid	7/8" x 5-1/2" x 20'	48
Vista	Riser	1 x 8 x 12' Riser	1/2" x 8" x 12'	40
Vista	Fascia	1 x 12 x 12' Fascia	1/2" x 11-1/4" x 12'	40



Available Colors:

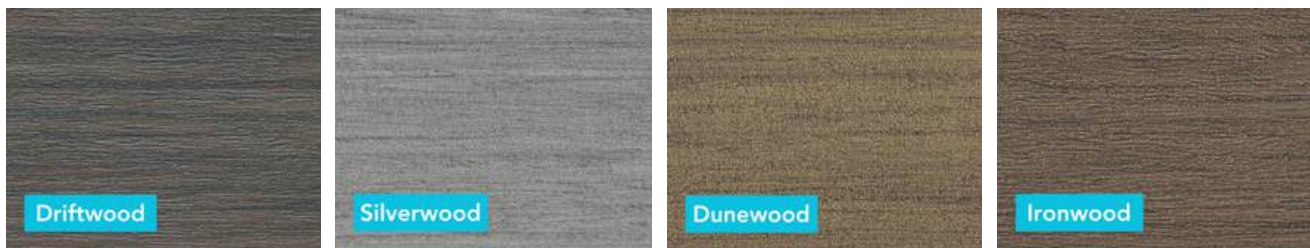

Available Profiles:



Features & Benefits:

- Now manufactured with Enhanced Traction for increased slip resistance
- Scratch-resistant cap with a strong, dense composite core
- Excellent value; works for a wide range of budgets and home styles
- Multi-tone colors for an authentic and real wood-like look
- Industry-leading warranty: 25-year Structural, 25-year Stain & Fade, and 25-year Removal & Replacement

DECKORATORS DECKING - SUMMIT

A mineral-based composite technology line, which provides the industry's best strength-to-weight ratio. Summit is a lower price mineral-based composite that has more basic color and streaking appearance. It comes with a 25-year structural and 25-year stain & fade warranty.

Available Sizes:

Line	Type	Item	Actual Size	Unit Size
Summit	Grooved Deck Board	5/4 x 6 x 12' Grooved	7/8" x 5-1/2" x 12'	48
Summit	Grooved Deck Board	5/4 x 6 x 16' Grooved	7/8" x 5-1/2" x 16'	48
Summit	Grooved Deck Board	5/4 x 6 x 20' Grooved	7/8" x 5-1/2" x 20'	48
Summit	Solid Deck Board	5/4 x 6 x 16' Solid	7/8" x 5-1/2" x 16'	48
Summit	Solid Deck Board	5/4 x 6 x 20' Solid	7/8" x 5-1/2" x 20'	48
Summit	Fascia	1 x 12 x 12 Fascia	7/16" x 11-1/4" x 12'	40



Available Colors:

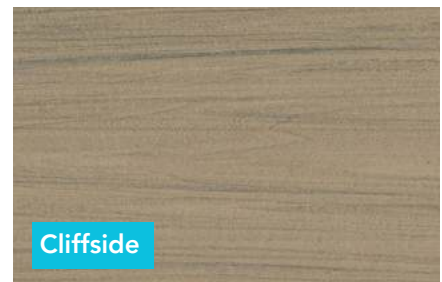
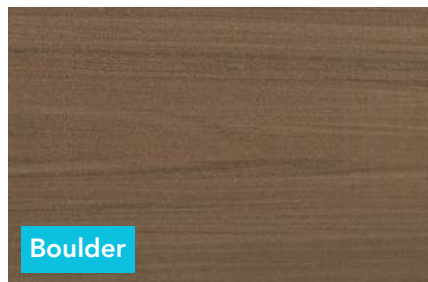

Available Profiles:



Features & Benefits:

- Mineral Based Composite technology
- Virtually zero thermal expansion and contraction
- Incredible strength and durability; virtually impossible to crack and break
- Significantly lighter than traditional wood plastic composites
- Enhanced traction for additional slip resistance
- Approved for ground contact and water installation
- Industry-leading warranty: 25-year Structural, 25-year Stain & Fade, and 25-year Removal & Replacement

DECKORATORS DECKING - VOYAGE

A mineral-based composite technology line, which provides the industry's best strength-to-weight ratio. Featuring a fiber-like structure similar to wood, Voyage has unmatched strength that is nearly 35% lighter than traditional composites and similar in weight to PVC.

Available Sizes:

Line	Type	Item	Actual Size	Unit Size
Voyage	Grooved Deck Board	5/4 x 6 x 12' Grooved	7/8" x 5-1/2" x 12'	48
Voyage	Grooved Deck Board	5/4 x 6 x 16' Grooved	7/8" x 5-1/2" x 16'	48
Voyage	Grooved Deck Board	5/4 x 6 x 20' Grooved	7/8" x 5-1/2" x 20'	48
Voyage	Solid Deck Board	5/4 x 6 x 16' Solid	7/8" x 5-1/2" x 16'	48
Voyage	Solid Deck Board	5/4 x 6 x 20' Solid	7/8" x 5-1/2" x 20'	48
Voyage	Riser	1 x 8 x 12' Riser	7/16" x 8" x 12'	40
Voyage	Fascia	1 x 12 x 12' Fascia	7/16" x 11-1/4" x 12'	40
Voyage	Dark Slate Accent Board	5/4 x 6 x 21' Solid	7/8" x 5-1/2" x 21'	48
Voyage	Dark Slate Accent Riser	1 x 8 x 12' Riser	7/16" x 8" x 12'	40
Voyage	Dark Slate Accent Fascia	1 x 12 x 12' Fascia	7/16" x 11-1/4" x 12'	40

50 YEAR
STRUCTURAL

25 YEAR
STAIN & FADE

25 YEAR
REMOVAL & REPLACEMENT

LIMITED WARRANTY

Available Colors:



Available Profiles:

Grooved-Edge

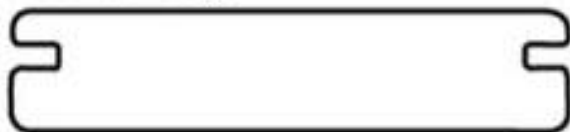

Solid-Edge



Features & Benefits:

- Mineral Based Composite technology
- Virtually zero thermal expansion and contraction
- Incredible strength and durability; virtually impossible to crack and break
- Lightweight easy to work with and install; 35% lighter than traditional wood plastic composites
- Approved for ground contact and water installation
- Won't splinter, sag, chalk, or crack
- Stain and fade-resistant cap stock
- Can be used as residential and commercial cladding

DECKORATORS FASTENERS

VENTURE LINE FASTENERS

Item	Hidden Fasteners		
	SKU	Size	Coverage
Camo Stealthlock	CSL500	90 COUNT	50 SQ FT
Camo Stealthlock	CSL250	450 COUNT	250 SQ FT
Camo Stealthlock	CSL500	900 COUNT	500 SQ FT



Line	Color	165 Plugs, 150 Screws, 1 Tool	
		SKU	Size
Venture	Sandbar	DPLUGSB	100 LF/45 SQ FT
Venture	Saltwater	DPLUGSW	100 LF/45 SQ FT

Line	Color	2-3/4" Deck Screws (100 Count)	
		SKU	Size
Venture	Sandbar	D234BCKSKIN100	100 Pc/30 Sq Ft
Venture	Saltwater	D234GRAY100	100 Pc/30 Sq Ft

Line	Color	2-3/4" Deck Screws (350 Count)	
		SKU	Size
Venture	Sandbar	D234BCKSKIN350	350 Pc/100 Sq Ft
Venture	Saltwater	D234GRAY350	350 Pc/100 Sq Ft

Line	Color	1-7/8" Screws for Risers & Fascia (100 Count)	
		SKU	Size
Venture	Sandbar	DF178BS	30 LF/Riser, 60 LF/Fascia
Venture	Saltwater	DF178GR	30 LF/Riser, 60 LF/Fascia



Cap Top w/ Epoxy Coated Carbon Steel
100 pcs/30 sq ft



Cap Top w/ Epoxy Coated Carbon Steel
100 pcs/30 sq ft

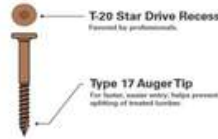

T-20 Star Drive Recess
Formed by professionals

Type 17 Auger Tip
For better, easier entry helps prevent splitting of treated lumber

VISTA LINE FASTENERS

Item	Hidden Fasteners		
	SKU	Size	Coverage
Camo Stealthlock	CSL500	90 COUNT	50 SQ FT
Camo Stealthlock	CSL250	450 COUNT	250 SQ FT
Camo Stealthlock	CSL500	900 COUNT	500 SQ FT



Line	Color	165 Plugs, 150 Screws, 1 Tool	
		SKU	Size
Vista	Driftwood	DPLUGKTWDET	100 LF/45 SQ FT
Vista	Ironwood	DPLUGKTWDET	100 LF/45 SQ FT
Vista	Silverwood	DPLUGKTWDET	100 LF/45 SQ FT
Vista	Dunewood	DPLUGKTWDET	100 LF/45 SQ FT

Line	Color	2-3/4" Deck Screws (100 Count)	
		SKU	Size
Vista	Driftwood	D234DKSLATE100	100 Pc/30 Sq Ft
Vista	Ironwood	D234CHOC100	100 Pc/30 Sq Ft
Vista	Silverwood	D234GRAY100	100 Pc/30 Sq Ft
Vista	Dunewood	D234BCKSKIN100	100 Pc/30 Sq Ft

Line	Color	2-3/4" Deck Screws (350 Count)	
		SKU	Size
Vista	Driftwood	D234DKSLATE350	350 Pc/100 Sq Ft
Vista	Ironwood	D234CHOC350	350 Pc/100 Sq Ft
Vista	Silverwood	D234GRAY350	350 Pc/100 Sq Ft
Vista	Dunewood	D234BCKSKIN350	350 Pc/100 Sq Ft

Line	Color	1-7/8" Screws for Risers & Fascia (100 Count)	
		SKU	Size
Vista	Driftwood	DF178DS	30 LF/Riser, 60 LF/Fascia
Vista	Ironwood	DF178CI	30 LF/Riser, 60 LF/Fascia
Vista	Silverwood	DF178GR	30 LF/Riser, 60 LF/Fascia
Vista	Dunewood	DF178BS	30 LF/Riser, 60 LF/Fascia



Cap Top w/ Epoxy Coated Carbon Steel
100 pcs/30 sq ft



Cap Top w/ Epoxy Coated Carbon Steel
100 pcs/30 sq ft



T-20 Star Drive Recess
Formed by professionals

Type 17 Auger Tip
For better, easier entry helps prevent splitting of treated lumber

DECKORATORS FASTENERS

SUMMIT LINE FASTENERS

Item	Hidden Fasteners		
	SKU	Size	Coverage
Camo Stealthlock	CSL500	90 COUNT	50 SQ FT
Camo Stealthlock	CSL250	450 COUNT	250 SQ FT
Camo Stealthlock	CSL500	900 COUNT	500 SQ FT



Line	Color	165 Plugs, 150 Screws, 1 Tool	
		SKU	Size
Summit	Glacier	DPLUGTGLAC	100 LF/45 SQ FT
Summit	Cliffside	DPLUGTCLIFF	100 LF/45 SQ FT
Summit	Boulder	DPLUGTBOUL	100 LF/45 SQ FT



Line	Color	2-3/4" Deck Screws (100 Count)	
		SKU	Size
Summit	Glacier	D234GRAY100	100 Pc/30 Sq Ft
Summit	Cliffside	D234SAND100	100 Pc/30 Sq Ft
Summit	Boulder	D234BRN100	100 Pc/30 Sq Ft



Cap-Tor® w/ Epoxy Coated Carbon Steel
Epoxy Coated Carbon Steel

Line	Color	1-7/8" Screws for Risers & Fascia (100 Count)	
		SKU	Size
Summit	Glacier	DF178GR	30 LF/Riser, 60 LF/Fascia
Summit	Cliffside	DF178SAND	30 LF/Riser, 60 LF/Fascia
Summit	Boulder	DF178BR	30 LF/Riser, 60 LF/Fascia



T-20 Star Drive Recess
Formed by professionals.

Type 17 Auger Tip
For faster, easier entry, helps prevent splitting of treated lumber.

Line	Color	2-3/4" Deck Screws (350 Count)	
		SKU	Size
Summit	Glacier	D234GRAY350	350 Pc/100 Sq Ft
Summit	Cliffside	D234SAND350	350 Pc/100 Sq Ft
Summit	Boulder	D234BRN350	350 Pc/100 Sq Ft



Cap-Tor® w/ Epoxy Coated Carbon Steel
Epoxy Coated Carbon Steel

VOYAGE LINE FASTENERS

Item	Hidden Fasteners		
	SKU	Size	Coverage
Camo Stealthlock	CSL500	90 COUNT	50 SQ FT
Camo Stealthlock	CSL250	450 COUNT	250 SQ FT
Camo Stealthlock	CSL500	900 COUNT	500 SQ FT



Line	Color	165 Plugs, 150 Screws, 1 Tool	
		SKU	Size
Voyage	Sierra	DPLUGTSSI	100 LF/45 SQ FT
Voyage	Tundra	DPLUGTTU	100 LF/45 SQ FT
Voyage	Mesa	DPLUGTME	100 LF/45 SQ FT
Voyage	Costa	DPLUGTCO	100 LF/45 SQ FT
Voyage	Khaya	DPLUGTKH	100 LF/45 SQ FT
Voyage	Sedona	DPLUGTSE	100 LF/45 SQ FT
Voyage	Dark Slate	DPLUGTDS	100 LF/45 SQ FT



Line	Color	2-3/4" Deck Screws (350 Count)	
		SKU	Size
Voyage	Sierra	D234DKGRAY350	350 Pc/100 Sq Ft
Voyage	Tundra	D234WNGRAY350	350 Pc/100 Sq Ft
Voyage	Mesa	D234BRN350	350 Pc/100 Sq Ft
Voyage	Costa	D234TAN350	350 Pc/100 Sq Ft
Voyage	Khaya	D234CHOC350	350 Pc/100 Sq Ft
Voyage	Sedona	D234DKSKIN350	350 Pc/100 Sq Ft
Voyage	Dark Slate	D234DKSLATE350	350 Pc/100 Sq Ft



Cap-Tor® w/ Epoxy Coated Carbon Steel
Epoxy Coated Carbon Steel

Line	Color	2-3/4" Deck Screws (100 Count)	
		SKU	Size
Voyage	Sierra	D234DKGRAY100	100 Pc/30 Sq Ft
Voyage	Tundra	D234WNGRAY100	100 Pc/30 Sq Ft
Voyage	Mesa	D234BRN100	100 Pc/30 Sq Ft
Voyage	Costa	D234TAN100	100 Pc/30 Sq Ft
Voyage	Khaya	D234CHOC100	100 Pc/30 Sq Ft
Voyage	Sedona	D234DKSKIN100	100 Pc/30 Sq Ft
Voyage	Dark Slate	D234DKSLATE100	100 Pc/30 Sq Ft



Cap-Tor® w/ Epoxy Coated Carbon Steel
Epoxy Coated Carbon Steel

Line	Color	1-7/8" Screws for Risers & Fascia (100 Count)	
		SKU	Size
Voyage	Sierra	DF178DG	30 LF/Riser, 60 LF/Fascia
Voyage	Tundra	DF178WG	30 LF/Riser, 60 LF/Fascia
Voyage	Mesa	DF178BR	30 LF/Riser, 60 LF/Fascia
Voyage	Costa	DF178TAN	30 LF/Riser, 60 LF/Fascia
Voyage	Khaya	DF178CL	30 LF/Riser, 60 LF/Fascia
Voyage	Sedona	DF178SS	30 LF/Riser, 60 LF/Fascia
Voyage	Dark Slate	DF178DS	30 LF/Riser, 60 LF/Fascia



T-20 Star Drive Recess
Formed by professionals.

Type 17 Auger Tip
For faster, easier entry, helps prevent splitting of treated lumber.

DECKORATORS FULL 11-1/4" WIDE STEP TREADS



Available Sizes:

Line	Type	Colors	Actual Size
<i>Voyage</i>	<i>Full Step Tread</i>	<i>Khaya, Tundra, Dark Slate</i>	<i>7/8" x 11-1/4" x 13'</i>

ZIP JOIST TAPE



DECKING

Available Sizes:

Item	Actual Size	Color
<i>Zip Joist Tape</i>	<i>2" x 75'</i>	<i>Black</i>



DECKORATORS PORCH FLOORING

A mineral based composite porch flooring board with the look of exotic hardwoods without the maintenance. Deckorators Porch Flooring comes in two colors: Kettle and Chicory. It's a great option for a low maintenance porch flooring.

Available Sizes:

Item	Actual Size	Colors	Material
Porch Flooring 1x4x10' T&G	7/8" x 3-1/8" x 10'	Kettle & Chicory	Mineral Based Composite
Porch Flooring 1x4x12' T&G	7/8" x 3-1/8" x 12'	Kettle & Chicory	Mineral Based Composite
Porch Flooring 1x4x16' T&G	7/8" x 3-1/8" x 16'	Kettle & Chicory	Mineral Based Composite
Porch Flooring 1x4x12' Solid	7/8" x 3-1/8" x 12'	Kettle & Chicory	Mineral Based Composite

Available Colors:



Kettle

Chicory



Features & Benefits:

- Mineral Based Composite technology
- Virtually zero thermal expansion and contraction
- Incredible strength and durability; virtually impossible to crack and break
- Lightweight easy to work with and install; 35% lighter than traditional wood plastic composites
- Approved for ground contact and water installation
- Won't splinter, sag, chalk, or crack
- Stain and fade-resistant cap stock
- Industry-leading warranty: 50-year Structural, 25-year Stain & Fade, and 25-year Removal & Replacement

DECKORATORS ALX CONTEMPORARY RAILING

Pre-assembled railing with a sleek and modern appearance, with a beautiful powder-coated finish. This deck railing is engineered to resist scratches while enduring humidity and weather changes without corroding.



- Welded panels for strength and ease of installation
- 6' & 8' on-center lengths when installing with 2-1/2" posts'
- 6' & 8' adjustable stair rail panels
- Square balusters

Available in:

Textured Black

Special Order:

Textured White

Textured Bronze

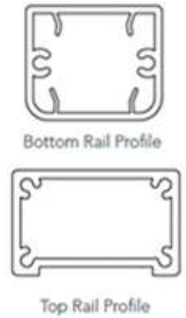

ALX Contemporary Railing

A pre-assembled and welded aluminum railing system

Posts Kits

Each post kit includes (1) Powder coated aluminum post, welded to (1) aluminum post base, (1) powder coated post base trim, (1) powder coated post cap and skirt, and leveling plates and screws. Standard 2.5" post bases measure 5" x 5"; oversized 4" post bases measure 6.5" x 6.5".

Section	SKU	Actual Size	Item	Unit Size
Rail Posts	D39TBLKPK	2-1/2" x 2-1/2" x 39" Tall	Square Black 39" Post Kit For Railing Section	42
Stair Posts	D49TBLKPK	2-1/2" x 2-1/2" x 49" Tall	Square Black 49" Post Kit For Stair Section	42
4x4 Rail Posts	D4439TBLKPK	4" x 4" x 39" Tall	4x4 Square Black 39" Post Kit For Railing Section	25
4x4 Stair Posts	D4449TBLKPK	4" x 4" x 49" Tall	4x4 Square Black 49" Post Kit For Stair Section	25

Railing Kits

Section	SKU	Actual Size	Item	Unit Size
<i>Each kit includes 1 pre-assembled welded 6' on center rail, using 2 68.5" long rails, and 15 30" rectangle balusters. Includes Brackets</i>				
6' Railing	D6OCTBLK	6' o.c. Rail Section, 36" Tall	ALX Contemporary 6' Textured Black Rail	16
<i>Each kit includes 1 pre-assembled welded 8' on center rail, using 2 92.5" long rails, and 20 30" rectangle balusters. Includes Brackets</i>				
8' Railing	D8OCTBLK	8' o.c. Rail Section, 36" Tall	ALX Contemporary 8' Textured Black Rail	16

Rackable stairs. Each 6' railing kit includes one rackable and pre-assembled 6' rail section (two 72" rails, 15 35" balusters, and brackets)

6' Stair Railing	D6STOCTBLK	6' o.c. Rail Section, 36" Tall	ALX Contemporary 6' Textured Black Stair	16
<i>Rackable stairs. Each 8' railing kit includes one rackable and pre-assembled 8' rail section (two 96" rails, 20 35" balusters, and brackets)</i>				
8' Stair Railing	D8STOCTBLK	8' o.c. Rail Section, 36" Tall	ALX Contemporary 8' Textured Black Stair	16

Bracket Template

Rail Bracket Template can be used for both 2.5" x 2.5" and 4" x 4" posts. Also works for both 36" and 42" rail heights.

Section	SKU	Item	Unit Size
Rail Bracket Template	DALXCTEMP	ALX Contemporary Rail Bracket Template	1

Additional Brackets

Section	SKU	Item	Unit Size
Rail Brackets	DT2PBLK	2 Piece Top & Bottom Rail Bracket - Black	1
Stair Brackets	DTBLKSTR	Angle/Swivel Top & Bottom Stair Brackets - Black	1

DECKORATORS RAPID RAIL

An innovative packaged and kitted aluminum railing system that can be easily and quickly installed. Rapid Rail Aluminum Deck Railing offers a modern design with clean lines and a finish coating that resists scratches and corrosion.



- Easy, quick installation
- Modern design with square balusters
- Available in 6' & 8' on-center length when installing with 2-1/2" post
- Code-compliant graspable profile
- Two-piece rails and brackets
- Drop through balusters
- Works with Deckorators 2-1/2" and 4" aluminum posts

Available in:



Textured
Black

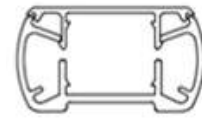

Top and Bottom Rail Profile

Rapid Rail

A low-cost and easy-to-install railing system with a clean modern design.

Posts Kits

Each post kit includes (1) Powder coated aluminum post, welded to (1) aluminum post base, (1) powder coated post base trim, (1) powder coated post cap and skirt, and leveling plates and screws. Standard 2.5" post bases measure 5" x 5", oversized 4" post bases measure 6.5" x 6.5".

System	Section	Color	SKU	Actual Size	Item	Unit Size
Rapid Rail	Rail Posts	Black	D39TBLKPK	2-1/2" x 2-1/2" x 39" Tall	Square Black 39" Post Kit For Railing Section	42
Rapid Rail	Stair Posts	Black	D49TBLKPK	2-1/2" x 2-1/2" x 49" Tall	Square Black 49" Post Kit For Stair Section	42
Rapid Rail	4x4 Rail Posts	Black	D4439TBLKPK	4" x 4" x 39" Tall	4x4 Square Black 39" Post Kit For Railing Section	25
Rapid Rail	4x4 Stair Posts	Black	D4449TBLKPK	4" x 4" x 49" Tall	4x4 Square Black 49" Post Kit For Stair Section	25

Railing Kits

System	Section	Color	SKU	Actual Size	Item	Unit Size
<i>Each 6' railing kit includes two 68.75" base rails and two 68.75" cap rails, and fifteen 32.5" balusters, and a small baluster and support/crush block baluster. Includes hardware and brackets.</i>						
Rapid Rail	6' Railing	Black	D6RRTBLK	6' o.c. Rail Section, 36" Tall	Rapid Rail 6' Textured Black Rail	56
<i>Each 8' railing kit includes two 92.75" base rails and two 92.75" cap rails, and twenty one 32.5" balusters and crush block balusters. Includes hardware and brackets.</i>						
Rapid Rail	8' Railing	Black	D8RRTBLK	8' o.c. Rail Section, 36" Tall	Rapid Rail 8' Textured Black Rail	56

<i>Each 6' stair railing kit includes two 68.75" base rails and two 68.75" cap rails, and twelve 32.5" balusters and crush block baluster. Includes hardware and brackets.</i>						
Rapid Rail	6' Stair Railing	Black	D6RRSTTBLK	6' o.c. Rail Section, 36" Tall	Rapid Rail 6' Textured Black Stair Rail	56
<i>Each 8' stair railing kit includes two 89.5" base rails and two 89.5" cap rails, and seventeen 32.5" balusters and crush block balusters. Includes hardware and brackets.</i>						
Rapid Rail	8' Stair Railing	Black	D8RRSTTBLK	8' o.c. Rail Section, 36" Tall	Rapid Rail 8' Textured Black Stair Rail	56

Bracket Template

Rail Bracket Template can be used for both 2.5" x 2.5" and 4" x 4" posts. Also works for both 36" and 42" rail heights.

System	Section	Color	SKU	Item	Unit Size
Rapid Rail	Rail Bracket Template	-	DRRTEMP	Rapid Rail Rail Bracket Template	1

Additional Brackets

System	Section	Color	SKU	Item	Unit Size
Rapid Rail	Rail Brackets	Black	DRRBKTBLK	Horizontal Rail Connector Kit - Black	4 per Pack
Rapid Rail	Stair Brackets	Black	DRRSBKTBLK	Stair Rail Connector Kit - Black	4 per Pack
Rapid Rail	Angle Brackets	Black	DRRABKTBLK	Horizontal Angle Rail Connector Kit - Black	4 per pack

SPECIAL ORDER

DECKORATORS CABLE RAILING

With Deckorators® Contemporary Cable Deck Railing, you can add a sleek, finished line to the edges of your deck, making your outdoor space safe and enjoyable year-round. Clean, minimalist lines without blocking the view.



- Powder-coated cable spacers match the top rail for a cohesive look
- 316 stainless-steel cable available in lengths from 5' to 50'
- Top rail available in 6' and 8' on-center lengths
- Pre-drilled line, corner, and end posts for 36" and 42" heights
- Rail, post, and cable kits sold individually

Special Order:



Textured Black



Textured White



Textured Bronze



Top Rail Profile

Cable Railing

Low cost railing system with clean, minimalist lines without blocking the view

Posts Kits

Each post kit includes (1) Powder coated aluminum post, welded to (1) aluminum post base, (1) powder coated post base trim, (1) powder coated post cap and skirt, and leveling plates and screws. (10 Cable Holes)

Section	SKU	Actual Size	Item	Unit Size
Horizontal/Line	D39BLKLCRPK	2-1/2" x 2-1/2" x 39" Tall	Textured Black 39" Line Post Kit For Railing Section	42
Horizontal/End	D39BLKECRPK	2-1/2" x 2-1/2" x 39" Tall	Textured Black 39" End Post Kit For Railing Section	42
Horizontal/Corner	D39BLKCCRPK	2-1/2" x 2-1/2" x 39" Tall	Textured Black 39" Corner Post Kit For Railing Section	42
Stair Middle	D49BLKDRMCPK	2-1/2" x 2-1/2" x 49" Tall	Textured Black 49" Post Kit For Stair Section	42
Stair Bottom	D49BLKSTRBCPK	2-1/2" x 2-1/2" x 49" Tall	Textured Black 49" Post Kit For Stair Section	42

Top Line Railing Kits

Section	SKU	Actual Size	Item	Unit Size
<i>Cable Rail Rectangular - Top 36" x 6' O.C. (Includes 1 spacer with 10 drilled holes)</i>				
Line Top Rail	D6CTRBLK	68.5" Rectangular	Textured Black Line Hardware Kit (1 rail with 2 brackets)	48
<i>Cable Rail Rectangular - Top 36" x 8' O.C. (Includes 2 spacers with 10 drilled holes)</i>				
Line Top Rail	D8CTRBLK	92.5" Rectangular	Textured Black Line Hardware Kit (1 rail with 2 brackets)	48

Top Stair Railing Kits

Section	SKU	Actual Size	Item	Unit Size
<i>Cable Rail Rectangular - Stair Top 6' (Includes 1 stair spacer with 12 drilled holes, cut down for 36")</i>				
Stair Top Rail	D6STRCBLK	72" Rectangular	Textured Black Stair Hardware Kit (1 rail with 2 brackets)	48
<i>Cable Rail Rectangular - Stair Top 8' (Includes 2 stair spacers with 12 drilled holes, cut down for 36")</i>				
Stair Top Rail	D8STRCMBLK	96" Rectangular	Textured Black Stair Hardware Kit (1 rail with 2 brackets)	48

Cable Rail Rope Hardware SS

Cable With Pre-Attached Threaded Stud (with 1 pull - lock fitting, cap, washers, and brass locknut)

Section	SKU	Actual Size	Item	Unit Size
Cable	D5CRRH	0.125" x 5'	Stainless Steel Cable With Pre-Attached Threaded Stud	1
Cable	D10CRRH	0.125" x 10'	Stainless Steel Cable With Pre-Attached Threaded Stud	1
Cable	D15CRRH	0.125" x 15'	Stainless Steel Cable With Pre-Attached Threaded Stud	1
Cable	D20CRRH	0.125" x 20'	Stainless Steel Cable With Pre-Attached Threaded Stud	1
Cable	D25CRRH	0.125" x 25'	Stainless Steel Cable With Pre-Attached Threaded Stud	1
Cable	D30CRRH	0.125" x 30'	Stainless Steel Cable With Pre-Attached Threaded Stud	1
Cable	D40CRRH	0.125" x 40'	Stainless Steel Cable With Pre-Attached Threaded Stud	1
Cable	D50CRRH	0.125" x 50'	Stainless Steel Cable With Pre-Attached Threaded Stud	1

Additional Brackets

Section	SKU	Item	Unit Size
Cable Line Rail Brackets	DT2PCRBK	Contemporary Rectangular In Line Top Rail Brackets	1
Cable Stair Brackets	DTBLKCSTR	Contemporary Rectangular Stair Top Rail Brackets	1

DECKING

SPECIAL ORDER

DECKORATORS PRIVACY SCREEN SYSTEM

Deck privacy screen, seamlessly adding definition and privacy, while offering creative freedom to mix and match screens, slats and decking components for a truly unique backyard style.



Deckorators Privacy Screen

Privacy Screen Frame Kits

Each frame kit includes (2) 44" top/bottom frame rails, (2) 72" side frame rails, (4) brackets, (2) .25-.625 x 44" filler strips, (6) .25-.625 x 24" filler strips, (2) .25-.25 x 44" H-Connector strips, (2) .875-.25 x 44" filler strip, (24) 1/2" channel spacers, (24) 5/8" channel spacers, and screws.

Section	SKU	Actual Size	Item	Unit Size
Frame Kit	DPFKBLK	4' x 6' - 72"	Privacy Screen Fence Frame Kit, Textured Black	36
Privacy Panels				
Privacy Panels	DPSPIER	2'x4'	2x4 HDPE Pier Black	8
Privacy Panels	DPSPALM	2'x4'	2x4 HDPE Palm Black	8
Privacy Panels	DPSWICK	2'x4'	2x4 HDPE Wicker Black	8
Privacy Panels	DPSWILD	2'x4'	2x4 HDPE Wildwood Black	8
Boards, for Privacy Slat Inserts				
Privacy Boards	DPSBDG	5/8" x 5-1/2" - 4'	Reversible WPC Board, Gray 4 Pack	32
Privacy Boards	DPSBDB	5/8" x 5-1/2" - 4'	Reversible WPC Board, Brown 4 Pack	32
Privacy Boards	DPSBDS	5/8" x 5-1/2" - 4'	Reversible WPC Board, Slate 4 Pack	32
Post Kit for Privacy Screen Kits				
Privacy Post	DPSPBLK	2.5" x 2.5" - 76"	Post Kit, w/ Cap & Trim, Textured Black	40



Palm



Pier



Wicker

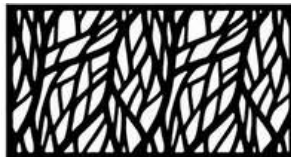

Wildwood

Gray, Brown & Slate



Available in:  Textured Black



DECK FASTENING SYSTEM



In Stock Fasteners & Gun:

Item	Box Size	Coverage
<i>2.5" Fastener</i>	<i>175 Pieces Per Box</i>	<i>100 SQ FT Per Box</i>

Item
Fastener Gun



Features & Benefits:

- Over 5 times faster than conventional screws. Can do 100 square feet in 10 minutes.
- No visible fasteners in the surface of the deck board, leaving a better visual appearance.
- No surface penetrations that allow water in, preventing rot, splitting or cracking.
- Boards lock to each other and to the joist, for the strongest frame possible.
- Strong stainless steel fasteners that are collated for easy handling and fast loading.
- Pneumatic tool, for the fastest and easiest installation possible.

TIGERDECK DECKING



Features & Benefits:

- South American Hardwood timber that is milled in USA
- Last 2-3 times longer than Cedar or Treated and comes with a 25 year warranty
- Half the cost of comparable IPE
- Naturally resistant to rot, insects and decay
- Incredibly dense and strong; 5/4" decking can span 24" O.C.
- Low maintenance and easy care



TIGERDECK DECKING



Available Sizes:

Item	Actual Size	Lengths	Application
1x6 Grooved Decking	0.72" x 5.44"	8' - 20' R/L	Deck Boards
5/4x6 Grooved Decking	0.94" x 5.44"	6' - 20' R/L	Deck Boards

Item	Actual Size	Lengths	Application
1x6 Smooth	0.72" x 5.44"	Varies	Fascia/Risers
5/4x6 Smooth	0.94" x 5.44"	Varies	Fascia/Risers
5/4x8 Smooth	0.94" x 7.13"	Varies	Fascia/Risers
5/4x10 Smooth	0.94" x 9.13"	Varies	Fascia
5/4x12 Smooth	0.94" x 11.13"	Varies	Stepping/Jacks
4x4 Smooth	3.44" x 3.44"	Varies	Posts
2x4 Smooth	1.44" x 3.44"	Varies	Railing
5/4x6 Top Rail	0.94" x 5.44"	Varies	Railing
5/4x4 Sub Rail	0.94" x 3.44"	Varies	Railing
1x6 Reversible Porch Panel	0.94" x 5.44"	Varies	Porch Flooring
1x6 Nickel Gap	0.75" x 4.75"	Varies	Siding

Item	Coverage	Application
Bow Wrench	-	Installation
Tiger Clips	100 Sq Ft @ 16" O.C.	Deck Clips
Tiger Clips 45 Degree Angle	100 Sq Ft @ 16" O.C.	Deck Clips
TigerDeck Plugs & Screws	100/Kit	Plugs & Screws
TigerDeck Countersink Bit	-	Drill Bit

TIGERDECK RAINSCREEN SIDING



Profile:

4.7" Exposure - 255 LF/Square

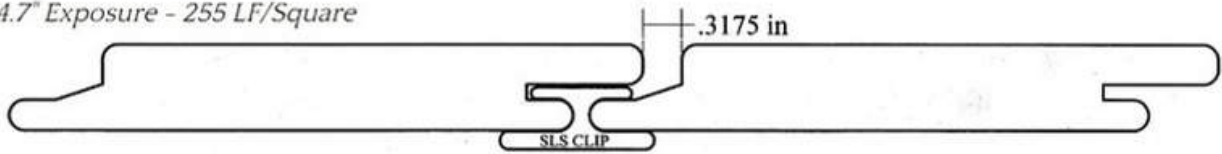

Available Sizes:

Item	Actual Size	Lengths	Application
1x6 Rainscreen Siding	0.7" x 5.125"	8' - 14'	Siding
Rainscreen Clips & Screws	235 Sq Ft	-	Siding Clips
Rainscreen Clips & Screws	50 Sq Ft	-	Siding Clips

Features & Benefits:

- Modern and clean look, well suited for commercial and multi-family projects
- Extremely durable and tough (50+ year life expectancy)
- Simple clip system installation and beautiful natural color and grain

CUTEK



Available Size:

Item	SKU	Size	Coverage	Finish
Cutek UV Protectant	CUTEK	1 Gallon	600 - 800 Sq Ft	Clear
Burnt Red Dye	BRCUTEK	3.2 Ounces	-	Burnt Red Tint
Walnut Dye	WNCUTEK	3.2 Ounces	-	Walnut Tint

To create the "Tigertone Tint," mix half a can of Burnt Red Dye with half a can of Walnut Dye per gallon.

Features & Benefits:

- Protects from the effects of moisture – minimizes warping, cupping, and splitting
- Protects from the inside out
- Works with all exterior wood species and most engineered wood products

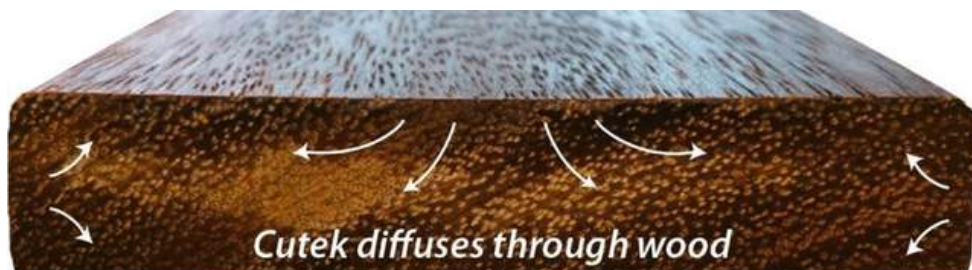

JAMES HARDIE FIBER CEMENT SIDING



STATEMENT COLLECTION

The statement collection is James Hardie's pre-finished siding and trim collection in their core colors. All statement items are in stock and ready for prompt shipment, including lap siding, shingles, panels, trim and soffit.

PRIMED COLLECTION

The primed collection is James Hardie's siding and trim collection in a basic primed finish. Primed collection items are available in wide variety of substrates.

DREAM COLLECTION

The dream collection is James Hardie's custom color collection. All of James Hardie's substrates are available in over 700 different colors and can be special ordered to the piece in a quick three-week lead time.



James Hardie - Pre-Finished Siding



Available Sizes:

Plank, Panel, Shingle and Batten Color Offering:



Item	Description	Actual Size	Exposure	Pcs/Square	Unit Size
Lap Siding	8.25" x 12' Cedarmil Lap	8.25" x 12'	7"	15	210
Shingles	Straight Edge Shingles	48" x 15.25"	7"	43	2 Squares
Shingles	Staggered Edge Shingles	48" x 15.25"	6.25"	50	2 Squares
Panels	4' x 10' Smooth Panel	4' x 10'	-	2.5	50
Panels	4' x 10' Cedarmill Panel	4' x 10'	-	2.5	50
Battens	4/4 x 2.5" Smooth Batten	0.75" x 2.5" x 12'	-	-	190
Battens	4/4 x 2.5" Rough Sawn Batten	0.75" x 2.5" x 12'	-	-	190

Features & Benefits:

- All lap, shingles, panels, and battens are in stock and available in ALL 16 colors
- Available in job-pack and less than unit quantities

SIDING & TRIM

James Hardie - Pre-finished Trim & Soffit



Available Sizes:



Item	Description	Actual Size	Unit Size
Trim	5/4 x 4 Smooth Trim - Statement	1" x 3.5" x 12'	240
Trim	5/4 x 6 Smooth Trim - Statement	1" x 5.5" x 12'	160
Trim	5/4 x 8 Smooth Trim - Statement	1" x 7.25" x 12'	120
Trim	5/4 x 12 Smooth Trim - Statement	1" x 11.25" x 12'	80
Trim	4/4 x 8 Smooth Trim - Statement	0.75" x 7.25" x 12'	156
Trim	5/4 x 4 Rough Sawn Trim - Statement	1" x 3.5" x 12'	240
Trim	5/4 x 6 Rough Sawn Trim - Statement	1" x 5.5" x 12'	160
Trim	5/4 x 8 Rough Sawn Trim - Statement	1" x 7.25" x 12'	120
Trim	4/4 x 8 Rough Sawn Trim - Statement	0.75" x 7.25" x 12'	156
Item	Description	Actual Size	Unit Size
Soffit	Cedarmill Vented - Statement *	12" x 12'	216
Soffit	Cedarmill Non-Vented - Statement *	12" x 12'	216

* Available in Arctic White, Cobble Stone, and Timber Bark

Features & Benefits:

- Pre-finished trim is available in six colors in both smooth and rough sawn trim
- Available in job-pack and less than unit quantities



James Hardie - Primed Lap, Trim, and Soffit

Available Sizes:

Primed Lap Siding				
Item	Description	SKU	Pcs/Square	Unit Size
Lap Siding	5.25" X 12' Primed Cedarmill	HPLKCM5	25	360
Lap Siding	6.25" X 12' Primed Cedarmill	HPLKCM6	20	308
Lap Siding	7.25" X 12' Primed Cedarmill	HPLKCM7	17	252
Lap Siding	8.25" X 12' Primed Cedarmill	HPLKCM8	15	230
Lap Siding	9.25" X 12' Primed Cedarmill	HPLKCM9	13	190
Lap Siding	12" X 12' Primed Cedarmill	HPLKCM12	10	152
Lap Siding	5.25" X 12' Primed Smooth	HPLKSM5	25	360
Lap Siding	6.25" X 12' Primed Smooth	HPLKSM6	20	308
Lap Siding	7.25" X 12' Primed Smooth	HPLKSM7	17	252
Lap Siding	8.25" X 12' Primed Smooth	HPLKSM8	15	230
Lap Siding	9.25" X 12' Primed Smooth	HPLKSM9	13	190
Lap Siding	12" X 12' Primed Smooth	HPLKSM12	10	152

Primed Trim				
Item	Description	SKU	Actual Size	Unit Size
Trim	4/4 x 2.5" Smooth Batten	442BSSM	0.75" x 2.5" x 12'	360
Trim	4/4 x 2.5" Rustic Batten	442BS	0.75" x 2.5" x 12'	360
Trim	4/4 x 4" Smooth Primed	44412HT	0.75" x 3.5" x 12'	312
Trim	4/4 x 6" Smooth Primed	44612HT	0.75" x 5.5" x 12'	208
Trim	4/4 x 8" Smooth Primed	44812HT	0.75" x 7.25" x 12'	156
Trim	4/4 x 12" Smooth Primed	441212HT	0.75" x 11.25" x 12'	104
Trim	5/4 x 4" Smooth Primed	54412HT	1" x 3.5" x 12'	240
Trim	5/4 x 6" Smooth Primed	54612HT	1" x 5.5" x 12'	160
Trim	5/4 x 8" Smooth Primed	54812HT	1" x 7.25" x 12'	120
Trim	5/4 x 12" Smooth Primed	541212HT	1" x 11.25" x 12'	80

Primed Soffit				
Description	Description	SKU	Actual Size	Unit Size
Soffit	12" Smooth Solid	HSFTSM12	12" x 12'	200
Soffit	16" Smooth Solid	HSFTSM16	16" x 12'	150
Soffit	24" Smooth Solid	HSFTSM24	24" x 8'	100
Soffit	12" Smooth Vented	HSFTSM12V	12" x 12'	200
Soffit	16" Smooth Vented	HSFTSM16V	16" x 12'	150
Soffit	24" Smooth Vented	HSFTSM24V	24" x 8'	100



James Hardie - Primed Panels, Shingles & Backer

Available Sizes:

<i>Primed Panels</i>				
Item	Description	SKU	Thickness	Unit Size
<i>Panels</i>	<i>4' x 8' Smooth Panel - PRIMED</i>	<i>HPNLSM8</i>	<i>5/16"</i>	<i>50</i>
<i>Panels</i>	<i>4' x 9' Smooth Panel - PRIMED</i>	<i>HPNLSM9</i>	<i>5/16"</i>	<i>50</i>
<i>Panels</i>	<i>4' x 10' Smooth Panel - PRIMED</i>	<i>HPNLSM10</i>	<i>5/16"</i>	<i>50</i>
<i>Panels</i>	<i>4' x 8' Cedarmill Panel - PRIMED</i>	<i>HPNLCM8</i>	<i>5/16"</i>	<i>50</i>
<i>Panels</i>	<i>4' x 9' Cedarmill Panel - PRIMED</i>	<i>HPNLCM9</i>	<i>5/16"</i>	<i>50</i>
<i>Panels</i>	<i>4' x 10' Cedarmill Panel - PRIMED</i>	<i>HPNLCM10</i>	<i>5/16"</i>	<i>50</i>
<i>Panels</i>	<i>4' x 8' Sierra 8" O.C. Panel - PRIMED</i>	<i>HPNLS88</i>	<i>5/16"</i>	<i>50</i>
<i>Panels</i>	<i>4' x 9' Sierra 8" O.C. Panel - PRIMED</i>	<i>HPNLS89</i>	<i>5/16"</i>	<i>50</i>
<i>Panels</i>	<i>4' x 10' Sierra 8" O.C. Panel - PRIMED</i>	<i>HPNLS810</i>	<i>5/16"</i>	<i>50</i>
<i>Panels</i>	<i>4' x 8' Stucco Panel - PRIMED</i>	<i>HPNLST8</i>	<i>5/16"</i>	<i>50</i>
<i>Panels</i>	<i>4' x 9' Stucco Panel - PRIMED</i>	<i>HPNLST9</i>	<i>5/16"</i>	<i>50</i>
<i>Panels</i>	<i>4' x 10' Stucco Panel - PRIMED</i>	<i>HPNLST10</i>	<i>5/16"</i>	<i>50</i>
<i>Primed Shingles</i>				
Item	Description	SKU	Thickness	Unit Size
<i>Shingles</i>	<i>Straight Edge Shingles - PRIMED</i>	<i>HSHGSE</i>	<i>1/4"</i>	<i>2 Squares</i>
<i>Shingles</i>	<i>Staggered Edge Shingles - PRIMED</i>	<i>HSHGSTG</i>	<i>1/4"</i>	<i>2 Squares</i>
<i>HardieBacker</i>				
Item	Description	SKU	Thickness	Unit Size
<i>Backer</i>	<i>1/4" 3' x 5' Hardiebacker</i>	<i>HB145</i>	<i>0.25"</i>	<i>60</i>
<i>Backer</i>	<i>1/2" (0.42" actual) 3' x 5' Hardiebacker</i>	<i>HB125</i>	<i>0.42"</i>	<i>50</i>



James Hardie - Dream Collection

Item	Description	Pcs/Square	Colors	Lead Time
Lap Siding	5.25" X 12' Cedarmill Lap - DREAM	25	All Dream Colors	3 Weeks
Lap Siding	6.25" X 12' Cedarmill Lap - DREAM	20	All Dream Colors	3 Weeks
Lap Siding	7.25" X 12' Cedarmill Lap - DREAM	17	All Dream Colors	3 Weeks
Lap Siding	8.25" X 12' Cedarmill Lap - DREAM	15	All Dream Colors	3 Weeks
Lap Siding	5.25" X 12' Smooth Lap - DREAM	25	All Dream Colors	3 Weeks
Lap Siding	6.25" X 12' Smooth Lap - DREAM	20	All Dream Colors	3 Weeks
Lap Siding	7.25" X 12' Smooth Lap - DREAM	17	All Dream Colors	3 Weeks
Lap Siding	8.25" X 12' Smooth Lap - DREAM	15	All Dream Colors	3 Weeks
Lap Siding	8.25" X 12' Beaded Smooth Lap - DREAM	15	All Dream Colors	3 Weeks

Shingles	Straight Edge Shingles - DREAM	43	All Dream Colors	3 Weeks
Shingles	Staggered Edge Shingles - DREAM	50	All Dream Colors	3 Weeks

Panels	4' X 8' Smooth Panel - DREAM	3.1	All Dream Colors	3 Weeks
Panels	4' X 8' Cedarmill Panel - DREAM	3.1	All Dream Colors	3 Weeks
Panels	4' X 10' Smooth Panel - DREAM	2.5	All Dream Colors	3 Weeks
Panels	4' X 10' Cedarmill Panel - DREAM	2.5	All Dream Colors	3 Weeks

Battens	4/4 x 2.5" Smooth Batten - DREAM	-	All Dream Colors	3 Weeks
Battens	4/4 x 2.5" Rough Sawn Batten - DREAM	-	All Dream Colors	3 Weeks

Item	Description	Actual Size	Colors	Lead Time
Trim	5/4 x 4 Trim - DREAM	1" x 3.5" x 12'	All Dream Colors	3 Weeks
Trim	5/4 x 6 Trim - DREAM	1" x 5.5" x 12'	All Dream Colors	3 Weeks
Trim	5/4 x 8 Trim - DREAM	1" x 7.25" x 12'	All Dream Colors	3 Weeks
Trim	5/4 x 10 Trim - DREAM	1" x 9.25" x 12'	All Dream Colors	3 Weeks
Trim	5/4 x 12 Trim - DREAM	1" x 11.25" x 12'	All Dream Colors	3 Weeks

Trim	4/4 x 4 Trim - DREAM	0.75" x 3.5" x 12'	All Dream Colors	3 Weeks
Trim	4/4 x 6 Trim - DREAM	0.75" x 5.5" x 12'	All Dream Colors	3 Weeks
Trim	4/4 x 8 Trim - DREAM	0.75" x 7.25" x 12'	All Dream Colors	3 Weeks
Trim	4/4 x 10 Trim - DREAM	0.75" x 9.25" x 12'	All Dream Colors	3 Weeks
Trim	4/4 x 12 Trim - DREAM	0.75" x 11.25" x 12'	All Dream Colors	3 Weeks

Item	Description	Actual Size	Colors	Lead Time
Soffit	12" Cedarmill Non-Vented - DREAM	12" x 12'	All Dream Colors	3 Weeks
Soffit	16" Cedarmill Non-Vented - DREAM	16" x 12'	All Dream Colors	3 Weeks
Soffit	24" Cedarmill Non-Vented - DREAM	24" x 8'	All Dream Colors	3 Weeks
Soffit	12" Cedarmill Vented - DREAM	12" x 12'	All Dream Colors	3 Weeks
Soffit	16" Cedarmill Vented - DREAM	16" x 12'	All Dream Colors	3 Weeks
Soffit	24" Cedarmill Vented - DREAM	24" x 8'	All Dream Colors	3 Weeks

JAMES HARDIE ARTISAN COLLECTION

The James Hardie Artisan Collections is a unique line of siding profiles that combine the quality and performance of James Hardie, with the craftsman look of classic siding profiles. Artisan is an extremely high performing siding product and very reasonably priced. It can be used for entire exterior siding, gable and dormer accents, as well as porch and patio ceilings and soffits.

Artisan V-Groove



Artisan Shiplap



Artisan Channel



Available Sizes:

Item	FP SKU	Actual Size	Exposure	Pcs/Square	Unit Size	Texture	Finish
<i>Artisan V-Groove</i>	<i>HPLKAVG8</i>	<i>5/8" x 8.25" x 12'</i>	<i>7"</i>	<i>14.3</i>	<i>126 Pcs</i>	<i>Smooth</i>	<i>Primed</i>
<i>Artisan Shiplap</i>	<i>HPLKAS10</i>	<i>5/8" x 10.25" x 12'</i>	<i>9"</i>	<i>11.1</i>	<i>105 Pcs</i>	<i>Smooth</i>	<i>Primed</i>
<i>Artisan Channel</i>	<i>HPLKSC10</i>	<i>5/8" x 10.25" x 12'</i>	<i>9"</i>	<i>11.1</i>	<i>105 Pcs</i>	<i>Smooth</i>	<i>Primed</i>

Features & Benefits:

- Unique Craftsman Profiles
- Slick blind nail design for hidden fasteners
- Backed by James Hardie's proven performance and 30-year warranty
- Can be mitered for clean professional corners
- Primed and can be painted any color

HARDIE COLOR MATCH CAULK & TOUCH UP PAINT



Available Caulk:

Color	Touch Up Paint SKU	Caulk SKU	Color	Touch Up Paint SKU	Caulk SKU
ARCTIC WHITE	HPAWKP	HCAW	EVENING BLUE	HPEBKP	HCEB
COBBLESTONE	HPCSKP	HCCS	DEEP OCEAN	HPDOKP	HCDO
LIGHT MIST	HPLMKP	HCLM	MONTEREY TAUPE	HPMTKP	HCMT
PEARL GRAY	HPPGKP	HCPG	NAVAJO BEIGE	HPNBKP	HCNB
AGED PEWTER	HPAPKP	HCAP	KHAKI BROWN	HPKBKP	HCKB
RICH ESPRESSO	HPREKP	HCRE	TIMBER BARK	HPTBKP	HCTB
GRAY SLATE	HPGSKP	HCGS	HEATHERED MOSS	HPHMKP	HCHM
IRON GRAY	HPIGKP	HCIG	MOUNTAIN SAGE	HPMSKP	HCMS
BOOTHBAY BLUE	HPBBKP	HCBB	COUNTRYLANE RED	HPCRKP	HCCR

Features & Benefits:

- Caulk for exterior door, window, and siding applications
- Color Matched to James Hardie Colors
- UV & Water Resistant - will not crack or yellow
- 1 tube covers 29 lineal feet at 1/4" bead width, or 13 lineal feet at a 3/8" bead width

SIDING & TRIM

GECKO GAUGES



Available Sizes:

SKU	PCS / Packaging	Applicable Widths	Adjustable
GECKO	2	5.25"-9.25" Siding	Yes

Sold in Pairs (2 Gauges per Box)

Features & Benefits:

- Speeds up installation by 47%, according to studies
- Allows for a single person install of lap siding
- Adjustable: works with various siding widths
- Ensures a professional installation with perfect and exact spacing between boards



BEAR SKINS

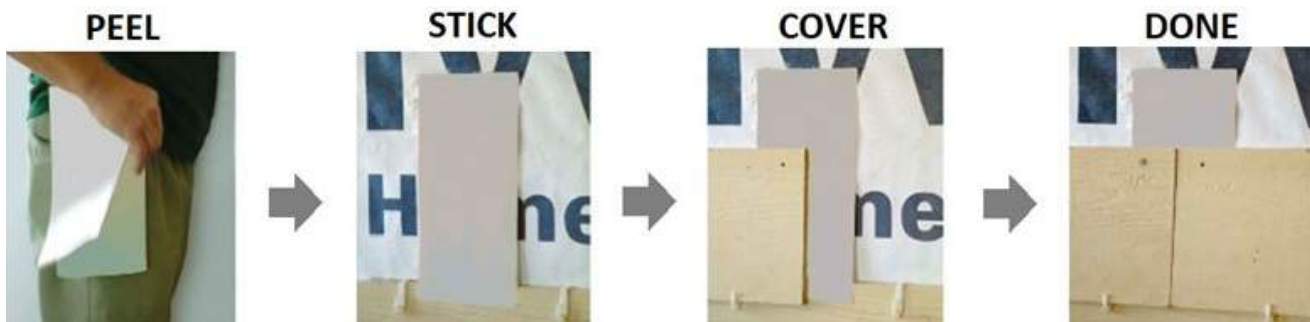
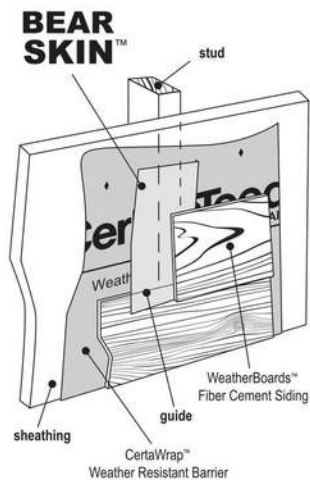

Available Sizes:

Item	SKU	Pad PCS	Coverage	Hardie Colors
Gray Bear Skin	HSBG	50 pcs	4-5 Squares	Whites, Blues, Grays
Tan Bear Skin	HSBT	50 pcs	4-5 Squares	Tans & Taupes
Dark Brown Bear Skin	HSBDB	50 pcs	4-5 Squares	Browns

Features & Benefits:

- Peel and stick: Sheets are pre-cut with a stick-it adhesive for the fastest application possible.
- Portable: Clips to belt or tool pouch
- Durable: 20 year UV rating
- Prevents moisture from penetrating butt joint
- Low-cost option to professionally finish James Hardie siding jobs

EASYTRIM REVEALS



EasyTrim Reveals® are a two-piece aluminum trim system that snaps together to protect your siding. Compatible with a wide range of siding solutions, EasyTrim Reveals® will save you time during installation while providing best-in-class weather protection and durability for the future.

EasyTrim works best with James Hardie panel siding and provides for a fast and simple installation that provides best-in-class water management, hidden fastening, and NO CAULKING. Builders and developers love EasyTrim because it simply works. It's easy to install, it saves their crews time, and it looks great.



Available Sizes:

Item	Application	SKU	Length	Finish
EZ 3	Panel Inside Corner	03EZPR	10'	Primed
EZ 13	Panel Outside Corner	13EZPR	10'	Primed
EZ 14	Panel Outside X Corner	14EZPR	10'	Primed
EZ 62	2-Piece Square Outside Corner	62EZPR	10'	Primed
EZ 4	Panel Horizontal Z Trim	04EZPR	10'	Primed
EZ 5	Panel Horizontal Reveal H Trim	05EZPR	10'	Primed
EZ 10	Panel Horizontal Base B Trim	10EZPR	10'	Primed
EZ 8	Panel General J Trim	08EZPR	10'	Primed
EZ 9	Panel Soffit J Trim	09EZPR	10'	Primed
EZ 21	2-Piece Soffit J Trin	21EZPR	10'	Primed
EZ 40	General J 3/4" LAP Trim	40EZPR	10'	Primed
EZ 68	General J 7/16" Panel Trim	68EZPR	10'	Primed
EZ 7	Panel Vertical 2-Piece U Trim	07EZPR	10'	Primed
EZ 19	Panel Vertical 2-Piece Window Jamb	19EZPR	10'	Primed
EZ 23	Panel Vertical 2-Piece Flat Trim	23EZPR	10'	Primed
EZ 28	Panel Window Drip Cap	28EZPR	10'	Primed
EZ 60	Perforated Vented Starter Strip	60EZPR	10'	Primed

EASYTRIM REVEALS

5/16" TRIM SYSTEM - LENGTH: 10'



OUTSIDE CORNERS

<p>EZ 13</p>  <p>Arrow Outside Corner 5/16" Trim</p>	<p>EZ 14</p>  <p>X Outside Corner 5/16" Trim</p>	<p>EZ 62</p>  <p>3-Piece Square Outside Corner 3/16" Panel Trim</p>
--	--	---





INSIDE CORNERS

<p>EZ 3</p>  <p>Inside Corner 5/16" Trim</p>

HORIZONTAL TRIMS

<p>EZ 4</p>  <p>Horizontal Z 5/16" Trim</p>	<p>EZ 5</p>  <p>Horizontal Reveal H 5/16" Trim</p>	<p>EZ 10</p>  <p>Horizontal Base B 5/16" Trim</p>
---	--	---

J TRIMS

<p>EZ 8</p>  <p>General J 5/16" Trim</p>	<p>EZ 9</p>  <p>Soffit J 5/16" Trim</p>	
<p>EZ 40</p>  <p>General J 3/4" LAP Trim</p>	<p>EZ 21</p>  <p>3-Piece Soffit J 5/16" Panel Trim</p>	<p>EZ 68</p>  <p>General J 3/16" Panel Trim</p>

VERTICAL TRIMS

<p>EZ 7</p>  <p>2-Piece Vertical U 5/16" Trim</p>	<p>EZ 19</p>  <p>3-Piece Vertical Window Joint 5/16" Panel Trim</p>	<p>EZ 25</p>  <p>Vertical H 5/16" Trim</p>
---	---	--

UNIVERSAL TRIMS

SLIMLINE TRIMS

<p>EZ 23</p>  <p>2-Piece Vertical SLT 5/16" Trim</p>
--

WINDOW FLASHING

<p>EZ 28</p>  <p>1-3/8" Window Drip Cap Flashing</p>
--

STARTER STRIP

<p>EZ 60</p>  <p>Perforated Vented Starter Strip Trim (Vinyl)</p>

3/4" TRIM SYSTEM'

OUTSIDE CORNERS

<p>EZ 34</p>  <p>X Outside Corner 3/4" Trim</p>

MIRATEC TRIM



Available Sizes:

Item	SKU	Actual Size	Lengths	Unit Size	Finish
1 x 2	12BM	0.75" x 2"	16'	168	Primed
1 x 3	13M	0.75" x 2.75"	16'	192	Primed
1 x 4	14M	0.75" x 3.5"	16'	144	Primed
1 x 6	16M	0.75" x 5.5"	16'	96	Primed
1 x 8	18M	0.75" x 7.25"	16'	72	Primed
1 x 10	110M	0.75" x 9.25"	16'	60	Primed
1 x 12	112M	0.75" x 11.25"	16'	48	Primed
1 x 16	116M	0.75" x 15.5"	16'	30	Primed
5/4 x 4	544M	1" x 3.5"	16'	144	Primed
5/4 x 6	546M	1" x 5.5"	16'	96	Primed
5/4 x 8	548M	1" x 7.25"	16'	72	Primed
5/4 x 10	5410M	1" x 9.25"	16'	60	Primed
5/4 x 12	5412M	1" x 11.25"	16'	48	Primed
5/4 x 16	5416M	1" x 15.5"	16'	30	Primed

Features & Benefits:

- Industry best 50-year warranty - resists moisture, rot and termites
- Half the cost of PVC and other premium composite trims
- Excellent woodgrain finish and pairs well with James Hardie siding

PVC TRIM



Available Sizes:

Item	Actual Size	Lengths	Unit Size	Texture	Protective Film
1 x 4	0.75" x 3.5"	12' & 18'	260	Smooth/Woodgrain	Yes
1 x 6	0.75" x 5.5"	12' & 18'	160	Smooth/Woodgrain	Yes
1 x 8	0.75" x 7.25"	12' & 18'	108	Smooth/Woodgrain	Yes
1 x 10	0.75" x 9.25"	18'	90	Smooth/Woodgrain	Yes
1 x 12	0.75" x 11.25"	12' & 18'	72	Smooth/Woodgrain	Yes
1 x 16	0.75" x 15.25"	18'	54	Smooth/Woodgrain	Yes
5/4 x 4	1" x 3.5"	18'	208	Smooth/Woodgrain	Yes
5/4 x 6	1" x 5.5"	18'	128	Smooth/Woodgrain	Yes
5/4 x 8	1" x 7.25"	18'	96	Smooth/Woodgrain	Yes
5/4 x 10	1" x 9.25"	18'	80	Smooth/Woodgrain	Yes
5/4 x 12	1" x 11.25"	18'	64	Smooth/Woodgrain	Yes

Features & Benefits:

- 100% cellular PVC
- Low maintenance
- Moisture and termite proof
- Mold and mildew resistant
- Lifetime Never Rot Warranty
- Lightweight and easy to work with
- Pre-finished white, but can be painted other colors

PVC PANELS & PVC PATTERN



Available Panel Sizes:

Item	Width	Available Lengths	Unit Size	Texture
3/8" PVC Panel	4'	8', 10'	25	Smooth/Smooth
1/2" PVC Panel	4'	8', 10'	25	Smooth/Smooth
3/4" PVC Panel	4'	8', 10', 12'	20	Smooth/Smooth
1" PVC Panel	4'	8'	20	Smooth/Smooth

Available Pattern Sizes:

Item	Actual Size	Lengths	Unit Size	Texture	Profile
1/2" x 6" PVC Pattern	0.5" x 5.25"	18'	96	Smooth	Beaded/V-Groove
1" x 6" x 18' Nickel Gap/WP4	0.75" x 5"	18'	72	Smooth	Nickel Gap/WP4

Profiles:

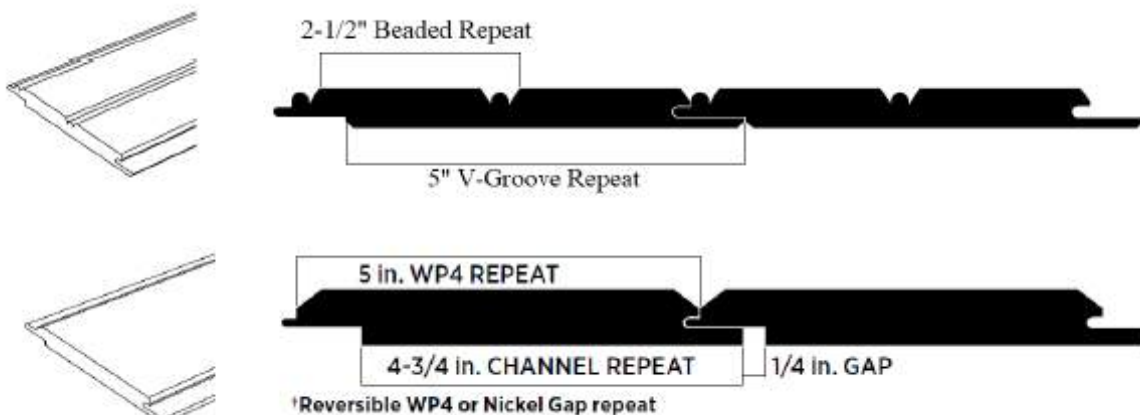

PVC MOULDINGS PROFILES:

Crowns

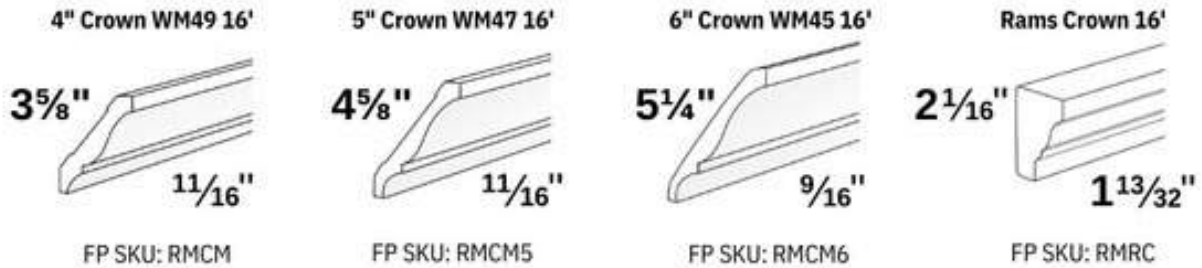

Moulds

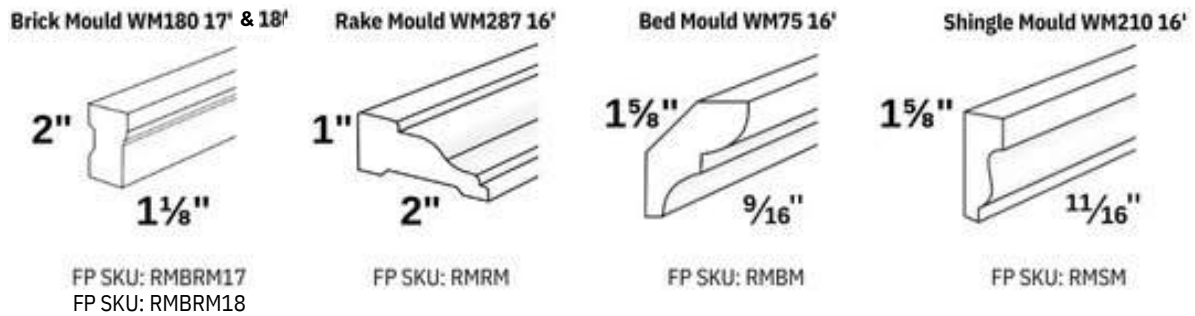

Trims

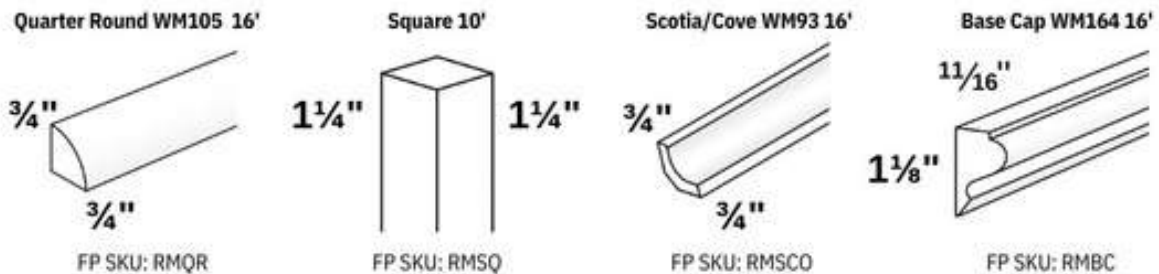

Caps, Sills, and Stops



**STOCKING
BLACK &
WHITE**

SIDING & TRIM

PVC COLUMNS



Available Sizes & Profiles:

Item	Actual Outside Dimension	Lengths	Unit Size	Texture	Corners
<i>8 x 8 Column Wrap</i>	<i>8" x 8"</i>	<i>9'</i>	<i>12</i>	<i>Smooth</i>	<i>Pre-Cut & Pre-Mitered</i>

Special Order Only:

<i>10 x 10 Column Wrap</i>	<i>10" x 10"</i>	<i>9'</i>	<i>12</i>	<i>Smooth</i>	<i>Pre-Cut & Pre-Mitered</i>
----------------------------	------------------	-----------	-----------	---------------	----------------------------------

Item	Column Size	Corners	Unit Size
<i>Classic Cap & Base</i>	<i>8" x 8"</i>	<i>Pre-Cut & Pre-Mitered</i>	<i>4</i>
<i>Estate Cap & Base</i>	<i>8" x 8"</i>	<i>Pre-Cut & Pre-Mitered</i>	<i>4</i>
Special Order Only:			
<i>Classic Cap & Base</i>	<i>10" x 10"</i>	<i>Pre-Cut & Pre-Mitered</i>	<i>4</i>
<i>Estate Cap & Base</i>	<i>10" x 10"</i>	<i>Pre-Cut & Pre-Mitered</i>	<i>4</i>



AFFINITY PANELIZED STONE



AFFINITY

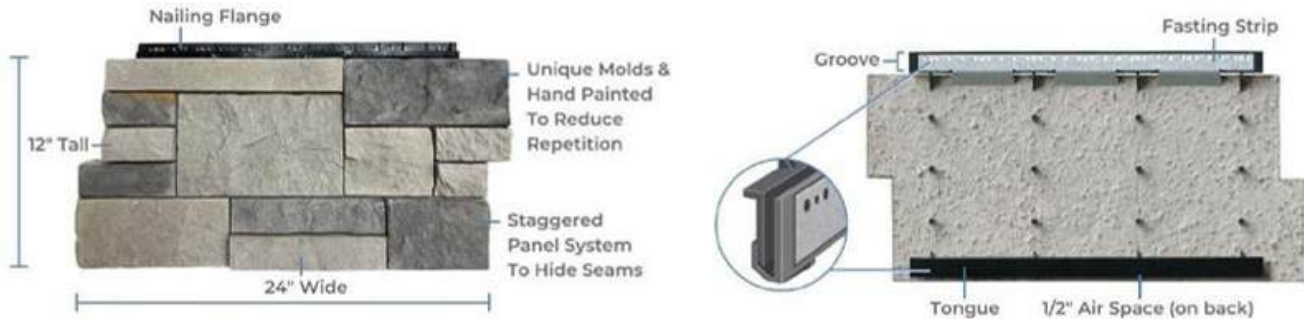

Available Sizes:

Stone:

Item	Actual Panel Size	Texture	Profile	Box Size
Aspen	12" High x 24" Wide	Ridge Cut & Cliff Ledge	Flats & Corners	5 Pcs (10 Sq Ft)
Highland	12" High x 24" Wide	Ridge Cut & Cliff Ledge	Flats & Corners	5 Pcs (10 Sq Ft)
Redwood	12" High x 24" Wide	Ridge Cut & Cliff Ledge	Flats & Corners	5 Pcs (10 Sq Ft)
Glacier	12" High x 24" Wide	Ridge Cut & Cliff Ledge	Flats & Corners	5 Pcs (10 Sq Ft)
Yukon	12" High x 24" Wide	Ridge Cut & Cliff Ledge	Flats & Corners	5 Pcs (10 Sq Ft)

Features & Benefits:

- Superior panel design that virtually eliminates panel seams to the naked eye
- Superb color selection designed specifically for the Midwest
- Intuitive and simple installation
- Bracketed tongue and groove system for seamless panel-to-panel connections
- Can be installed in any weather by any tradesmen
- 100% American Made (manufactured in Illinois)
- Zero cut column kits
- Great for Commercial or Residential Projects
- Primarily used in exterior siding, but can also be used for interior fireplaces and accent walls.

AFFINITY PANELIZED STONE

Available Colors and Profiles:

RIDGE CUT SERIES



CLIFF LEDGE SERIES



AFFINITY COLUMN KITS



Available Kits:

Zero Cut Column Kit Components

Column Stone Panels:

Item	Actual Panel Size	Texture	Column Height	Packaging
<i>Aspen Column Panels</i>	<i>12" High x 18.5" Wide</i>	<i>Ridge Cut & Cliff Ledge</i>	<i>3'</i>	<i>2 Boxes, 6 Pcs Per Box (3' Tall Column)</i>
<i>Highland Column Panels</i>	<i>12" High x 18.5" Wide</i>	<i>Ridge Cut & Cliff Ledge</i>	<i>3'</i>	<i>2 Boxes, 6 Pcs Per Box (3' Tall Column)</i>
<i>Redwood Column Panels</i>	<i>12" High x 18.5" Wide</i>	<i>Ridge Cut & Cliff Ledge</i>	<i>3'</i>	<i>2 Boxes, 6 Pcs Per Box (3' Tall Column)</i>
<i>Glacier Column Panels</i>	<i>12" High x 18.5" Wide</i>	<i>Ridge Cut & Cliff Ledge</i>	<i>3'</i>	<i>2 Boxes, 6 Pcs Per Box (3' Tall Column)</i>
<i>Yukon Column Panels</i>	<i>12" High x 18.5" Wide</i>	<i>Ridge Cut & Cliff Ledge</i>	<i>3'</i>	<i>2 Boxes, 6 Pcs Per Box (3' Tall Column)</i>

Column Components:

Item	Actual Size	Color
<i>6 x 6 Pre-Made Post Frame</i>	<i>14" x 14" x 36" Tall</i>	<i>-</i>
<i>Post Lag Screws</i>	<i>7"</i>	<i>-</i>
<i>6 x 6 Column Cap</i>	<i>22" x 22"</i>	<i>SAN/IVO/GRA/CHA</i>

Features & Benefits:

- Zero-cut column kits; pre-designed to install with no cuts or extra field work
- Pre-built two-piece framing column that wraps around 6x6 post
- Finished column measures 20" x 20" x 38" Tall
- Intuitive and simple installation
- Bracketed tongue and groove system for seamless panel to panel connections
- Can be installed in any weather by any tradesmen



AFFINITY ACCESSORIES

WAINSCOT CAPS

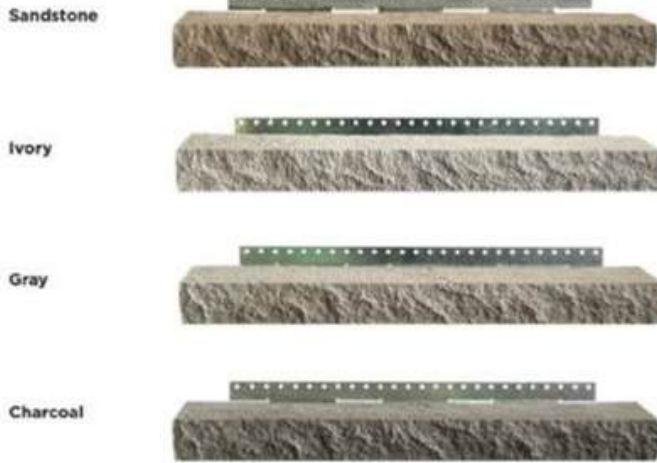

HEARTHSTONE

20" x 20" x 2"



UTILITIES



Light Block
8" x 10"



Single Receptacle Block
6" x 8"



Double Receptacle Block
8" x 8"

ACCESSORY COLOR GUIDE



Available Accessories:

Accessories:

Item	Actual Size	Color	Box Size
Starter Strip	10' Long	-	Sold Individually
Wainscot Cap (Top Flange)	24" Wide	Sandstone / Ivory / Gray / Charcoal	8 Pcs (16 LF)
Wainscot Cap (Bottom Flange)	24" Wide	Sandstone / Ivory / Gray / Charcoal	8 Pcs (16 LF)
Hearth Stone	20" x 20"	Sandstone / Ivory / Gray / Charcoal	Sold Individually
Light Block	8" Wide x 10" High	Sandstone / Ivory / Gray / Charcoal	Sold Individually
Single Receptacle Block	6" Wide x 8" High	Sandstone / Ivory / Gray / Charcoal	Sold Individually
Double Receptacle Block	8" Wide x 8" High	Sandstone / Ivory / Gray / Charcoal	Sold Individually
Hose Bib	5" Wide x 5" High	Sandstone / Ivory / Gray / Charcoal	Sold Individually
Metal Edge Trim	2" x 2" x 98"	Sandstone / Ivory / Gray / Charcoal	Sold Individually
Affinity Screws	1-5/8"	-	100 / 500

METAL EDGE TRIM 98" STRIP



ACCESSORY COLOR SELECTION GUIDE

Stone Color	Complementary	Contrasting
Aspen	Gray	Ivory/Charcoal
Highland	Gray/Sandstone	Ivory
Redwood	Gray/Sandstone	Ivory
Glacier	Ivory	Charcoal
Yukon	Charcoal	Ivory

SCREWS



FASTPLANK ALUMINUM SIDING



Available Sizes:

Siding & Trim

Item	Application	Size	Unit of Sale
6" Plank	Siding	6" x 16'	6 Pcs
Inside/Outside Corner	Corner Trim	12'	1 Pc
Two Piece J Trim	J Trim	12'	1 Pc
Two Piece Vertical Trim	Intermediate Trim	12'	1 Pc
One Piece J Trim	Window/Door Trim	12'	1 Pc
Perforated Starter	Starter Strip	12'	1 Pc

Connectors

Item	Application	Box Size
Wall Clip Connector	Siding Clip	100 Pcs
Plank Connector	Horizontal Plank Connector	50 Pcs
Plank Backer	Bottom & Top Edge Backer	50 Pcs
Wood Screw #10	Screws	250 Pcs



Features & Benefits:

- Extraordinary long-term durability and performance
- Made with a thick and high-quality aluminum
- Fantastic design for intuitive, easy, and fast installation
- Modern colors and look
- Excellent for commercial buildings

SPECIAL ORDER

WOODTONE RUSTICSERIES™

RusticSeries™ Lap is the original two-tone lap siding option; Combining the natural warmth and beauty of wood with the durability of fiber cement and composite products.



Available Sizes:

Brand	Item	Actual Size	Coverage	Texture	Unit of Sale
Woodtone RusticSeries™	Lap Siding	8.25" x 12'	15 Pcs/Sq	Cedarmill	4 Pcs
Woodtone RusticSeries™	Cedarmill Panels	4' x 10'	2.5 Pcs/Sq	Cedarmill	1 Pc
Woodtone RusticSeries™	Rustic Battens	3/4" x 2.5" x 12'	-	Cedarmill	1 Pc

Available Colors:



GATORBAR REBAR



Available Sizes:

Item	SKU	Thickness	Length	Weight	Bundle Size
#3 GatorBar	GB3	3/8"	20'	1.8 lbs/stick	25 pcs
#4 GatorBar	GB4	1/2"	20'	3.3 lbs/stick	15 pcs
#5 GatorBar	GB5	5/8"	20'	4.8 lbs/stick	10 pcs

Bends

Item	SKU	Thickness	Bundle Size
#3 24" x 24" GatorBar 90 Bend	GB32490	3/8"	25 pcs
#4 24" x 24" GatorBar 90 Bend	GB42490	1/2"	10 pcs
#5 24" x 24" GatorBar 90 Bend	GB52490	5/8"	10 pcs

Features & Benefits:

- 100% made in the USA
- More affordable, lighter, and stronger than traditional steel rebar
- Increases the lifespan of the concrete
- Price stability - pricing does not fluctuate like steel
- Completely rust resistant, even in high chloride and corrosive environments
- ICC certified for structural use
- #3 GatorBar is equivalent to #4 Steel

VALUFORM BENDER BOARD CONCRETE FORM



Available Sizes:

Item	Thickness	Size	Unit Size	Species
12" ValuForm Bender Board	7/16"	12" x 16'	168	Hardboard

Features & Benefits:

- Suitable for temporary landscape applications.
- Can be used with grade stakes, flexible, not brittle.
- Lightweight and flexible, easy to install without special tools.
- 16 ft. lengths minimize joints.
- Multiple uses for less job waste, more cost-effective than other bender board forming materials.

PLYFORM PANELS



Pine



Fir



(HDO) Film Face

Available Sizes:

Item	Finish	Estimated Pours	Species	Release Agent	Oil Edge Seal	# Plys
3/4" BB Fir	Smooth Woodgrain	5-10	Fir	Yes	Yes	7 ply
3/4" BB Pine	Smooth Woodgrain	5-10	Pine	Yes	Yes	7 ply
3/4" HDO (Film Face 2 Side)	Smooth Gloss	20-50	Pine	Yes	Yes	7-9 ply

Features & Benefits:

- Plyform Panels are designed for concrete pouring for foundations, bridges, tunnels, and more
- Each panel has a special finish and release agent that are uniquely designed to maximize the number of pours and improve the quality of the finish



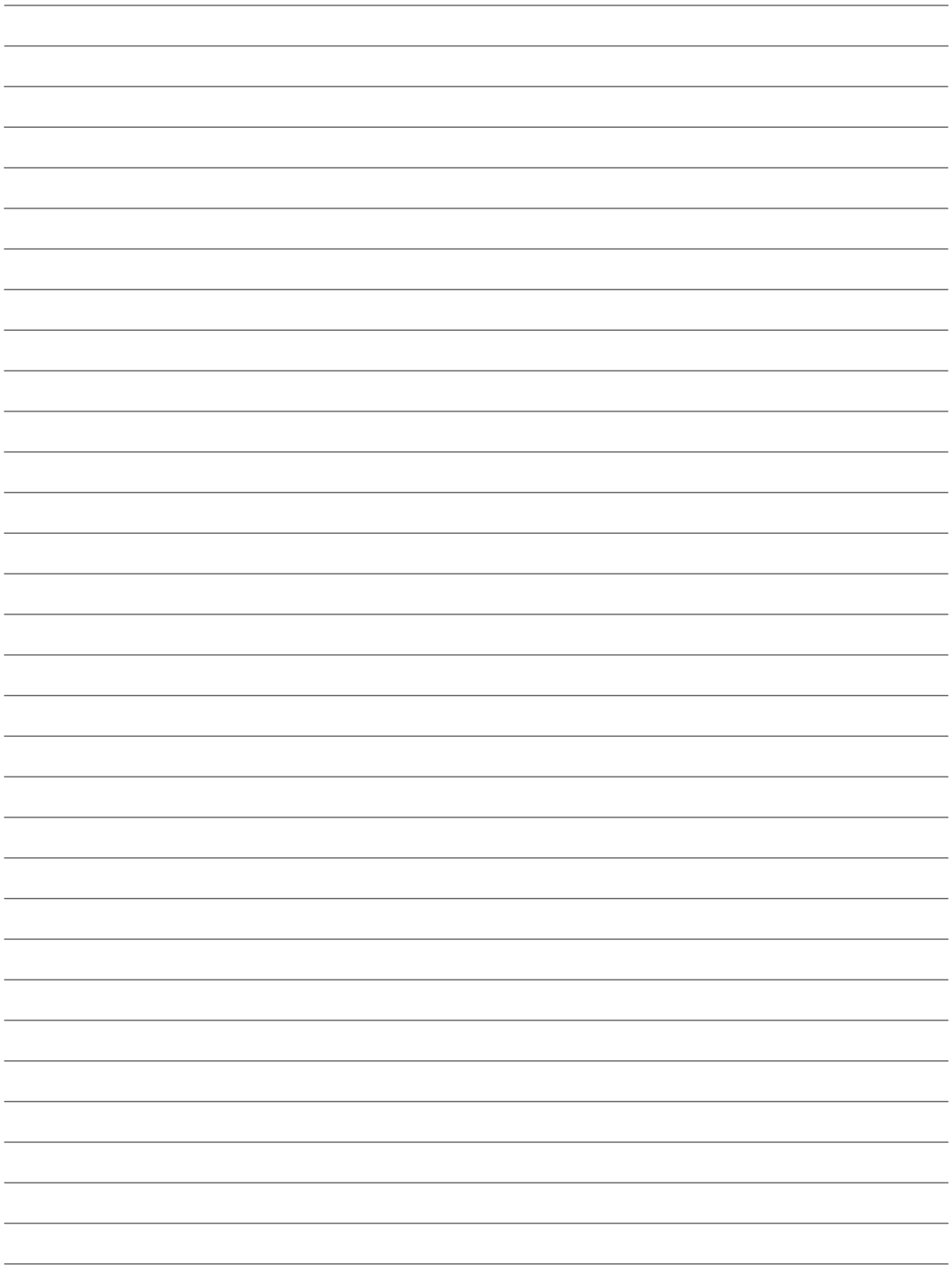



800.522.8905
9264 Manchester Rd, St. Louis, MO 63144
www.fp-supply.com